

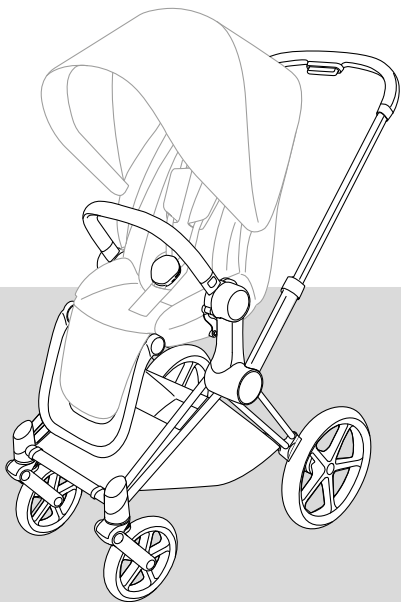

PRIAM

FRAME & SEAT





EN WARNING
DE WARNUNG
ES ADVERTENCIA
FR AVERTISSEMENT
PT AVISOS
IT WARNING
NL WAARSCHUWING
PL OSTRZEŻENIE
CS UPOZORNĚNÍ
SK UPOZORNENIE
SL OPOZORILO
HR UPOZORENJE
HU FIGYELMEZTETÉS
SE VARNING
NO ADVARSEL
FI VAROITUS
DA ADVARSEL
ET HOIATUS
LV BRĪDINĀJUMS
LT PERSPĖJIMAS
RU ВНИМАНИЕ
UK УВАГА
TR UYARI
EL ΠΡΟΕΙΔΟΠΟΙΗΣΗ
RO AVERTISMENTE
IS VIÐVÖRUN
MT TWISSIJA

AR
FA
YUE 警告
CMN 警告
JA 警告
KO 경고
BG ПРЕДУПРЕЖДЕНИЕ
SR UPOZORENJE
MS AMARAN
HI चेतावनी
TH คำเตือน
SQ PARALAJMËRIM
BS UPOZORENJE
ME UPOZORENJE
MK ПРЕДУПРЕДУВАЊЕ
HY ՉԳՈՒՇԱՑՈՒՄ
VI CẢNH BÁO

تحذير
اخطار

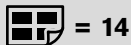

| | | | |
|-----------|---------------------|------------|-------------------------|
| EN | Maximum weights | TR | Maksimum ağırlıklar |
| DE | Maximalgewichte | EL | Μέγιστο βάρος |
| ES | Pesos máximos | RO | Greutăți maxime |
| FR | Poids maximum | IS | Hámarksþyngd |
| PT | Pesos máximos | MT | Piżijiet massimi |
| IT | Peso massimo | AR | الأوزان القصوى |
| NL | Maximumgewicht | FA | حداکثر وزن |
| PL | Dopuszczalna waga | YUE | 最大重量 |
| CS | Maximální hmotnosti | CMN | 最大重量 |
| SK | Maximálne hmotnosti | JA | 最大重量 |
| SL | Največje teže | KO | 최대 하중 |
| HR | Maksimalne težine | BG | Максимални тегла |
| HU | Maximális súlyok | SR | Maksimalne težine |
| SE | Max.vikter | MS | Berat maksimum |
| NO | Maksimumsvektor | HI | अधिकतम बजन |
| FI | Enimmäispainot | TH | น้ำหนักสูงสุด |
| DA | Maksimumvægt | SQ | Peshat maksimale |
| ET | Maksimaalne kaal | BS | Maksimalne težine |
| LV | Maksimālais svars | ME | Maksimalne težine |
| LT | Didžiausi svoriai | MK | Максимални тежини |
| RU | Максимальная масса | HY | Առավելագույն քաշեր |
| UK | Максимальна вага | VI | Các mức cân nặng tối đa |

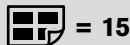

| | | | |
|-----------|----------------------------|------------|----------------------------|
| EN | Product registration | TR | Ürün kaydı |
| DE | Produktregistrierung | EL | Καταχώριση προϊόντος |
| ES | Registro del producto | RO | Înregistrarea produsului |
| FR | Enregistrement du produit | IS | Skráning tækis |
| PT | Registo do produto | MT | Reġistrazzjoni tal-prodott |
| IT | Registrazione del prodotto | AR | تسجيل المنتج |
| NL | Productregistratie | FA | ثبت محصول |
| PL | Rejestracja produktu | YUE | 產品註冊 |
| CS | Registrace výrobku | CMN | 产品注册 |
| SK | Registrácia výrobku | JA | 製品の登録 |
| SL | Registracija izdelka | KO | 제품 등록 |
| HR | Registracija proizvoda | BG | Регистрация на продукта |
| HU | Termékregisztráció | SR | Registracija proizvoda |
| SE | Produktregistrering | MS | Pendaftaran produk |
| NO | Produktregistrering | HI | उत्पाद पंजीकरण |
| FI | Tuotteen rekisteröinti | TH | การลงทะเบียนผลิตภัณฑ์ |
| DA | Produktregistrering | SQ | Regjistrimi i produktit |
| ET | Toote registreerimine | BS | Registracija proizvoda |
| LV | Produkta reģistrācija | ME | Registracija proizvoda |
| LT | Gaminio registracija | MK | Регистрација на производ |
| RU | Регистрация продукта | HY | Արձանագր գրանցում |
| UK | Реєстрація продукту | VI | Đăng ký sản phẩm |



= 16

| | | | |
|-----------|----------------|------------|-----------------|
| EN | Set up | TR | Kurulum |
| DE | Aufbau | EL | Στήσιμο |
| ES | Instalación | RO | Setare |
| FR | Montage | IS | Uppsetning |
| PT | Preparação | MT | Konfigurazzjoni |
| IT | Configurazione | AR | تنصيب |
| NL | Opbouw | FA | برپا کردن |
| PL | Montaż | YUE | 設置 |
| CS | Nastavení | CMN | 设置 |
| SK | Nastavenie | JA | セットアップ |
| SL | Nastavitev | KO | 설정 |
| HR | Postavljanje | BG | Настройка |
| HU | Felszerelés | SR | Postavljanje |
| SE | Inställning | MS | Persediaan |
| NO | Oppsett | HI | सेट अप |
| FI | Asennus | TH | การติดตั้ง |
| DA | Opsætning | SQ | Konfigurimi |
| ET | Seadistamine | BS | Postavljanje |
| LV | Uzstādīšana | ME | Postavljanje |
| LT | Nuostatos | MK | Поставување |
| RU | Установка | HY | Շարժափոխում |
| UK | Встановлення | VI | Cài đặt |



= 28

| | | | |
|-----------|----------|------------|-------------|
| EN | Brake | TR | Fren |
| DE | Bremse | EL | Φρένα |
| ES | Freno | RO | Frână |
| FR | Frein | IS | Bremsa |
| PT | Bloqueio | MT | Brejġ |
| IT | Freno | AR | المكابح |
| NL | Rem | FA | ترمز |
| PL | Hamulec | YUE | 剎車 |
| CS | Brzda | CMN | 刹车 |
| SK | Brzda | JA | ブレーキ |
| SL | Zavora | KO | 브레이크 |
| HR | Kočnica | BG | Спирачка |
| HU | Fék | SR | Kočnica |
| SE | Broms | MS | Brek |
| NO | Brems | HI | ब्रेक |
| FI | Jarru | TH | เบรค |
| DA | Bremse | SQ | Frenat |
| ET | Pidur | BS | Kočnica |
| LV | Bremze | ME | Kočnica |
| LT | Stabdys | MK | Сопирачка |
| RU | Тормоза | HY | Արզելակ |
| UK | Гальма | VI | Phanh thắng |



 = 29

| | | | |
|-----------|--------------------|------------|--------------|
| EN | Folding | TR | Katlama |
| DE | Faltung | EL | Αναδίπλωση |
| ES | Plegado | RO | Pliere |
| FR | Pliant | IS | Brjóta saman |
| PT | Fecho | MT | Tiwi |
| IT | Ripiegamento | AR | |
| NL | Vouwen | FA | |
| PL | Składanie | YUE | 折疊 |
| CS | Skládání | CMN | 折疊 |
| SK | Zloženie | JA | 折りたたみ |
| SL | Zlaganje | KO | 접기 |
| HR | Preklapanje | BG | Сгъване |
| HU | Összecsukás | SR | Preklapanje |
| SE | Ihopfällning | MS | Lipat |
| NO | Sammenlegging | HI | फोल्डिंग |
| FI | Kokoon taittaminen | TH | การพับ |
| DA | Sammenklapning | SQ | Palosja |
| ET | Kokkuvoltimine | BS | Preklapanje |
| LV | Salocīšana | ME | Preklapanje |
| LT | Lankstymas | MK | Склопување |
| RU | Складывание | HY | Ծախելը |
| UK | Складання | VI | Gập lại |

قابلية للطي
تا کردن



 = 31

| | | | |
|-----------|--------------------|------------|-------------------|
| EN | Harness | TR | Emniyet kemeri |
| DE | Gurtsystem | EL | Συγκράτηση |
| ES | Arnés | RO | Centură |
| FR | Harnais | IS | Beisli |
| PT | Arnês | MT | Ċinga tas-sigurtà |
| IT | Imbracatura | AR | طقم الشد |
| NL | Harnas | FA | سیدستم مهار |
| PL | Szelki | YUE | 安全帶 |
| CS | Popruh | CMN | 安全帶 |
| SK | Popruh | JA | 安全ベルト |
| SL | Varnostni pas | KO | 하네스 |
| HR | Sustav vezivanja | BG | Сбруя |
| HU | Biztonsági öv | SR | Sistem vezivanja |
| SE | Sele | MS | Abah-abah |
| NO | Beltesystem | HI | कबच |
| FI | Vyöjärjestelmä | TH | ระบบสายรัด |
| DA | Selesystem | SQ | Pajimet |
| ET | Turvarihmad | BS | Sistem vezivanja |
| LV | Drošības josta | ME | Sistem vezivanja |
| LT | Diržai | MK | Сигурносен каиш |
| RU | Ремни безопасности | HY | Ամրագրուի |
| UK | Ремінь | VI | Dây an toàn |



 = 34

| | |
|-----------------------------------|-----------------------------------|
| EN Two wheel mode | TR İki tekerlekli mod |
| DE Zweirad-Modus | EL Λειτουργία δύο τροχών |
| ES Modo de dos ruedas | RO Mod cu două roți |
| FR Mode deux roues | IS Stilling fyrir tvö hjól |
| PT Modo de duas rodas | MT Modalità b'żewġ roti |
| IT Modalità a due ruote | AR وضع العجلتين |
| NL Tweewiel-modus | FA حالت دوچرخ |
| PL Typ dwukołowy | YUE 兩輪模式 |
| CS Režim dvou kol | CMN 两轮模式 |
| SK Dvojkolesový režim | JA 2輪モード |
| SL Dvokolesni način | KO 두 휠 모드 |
| HR Režim rada s dva kotača | BG Режим с две колела |
| HU Kétkerek mód | SR Režim rada na dva točka |
| SE Tvåhjulsläge | MS Mod dua roda |
| NO Tohjulmodus | HI दो पहिया मोड |
| FI Kaksipyöräinen tila | TH โหมดสองล้อ |
| DA Tohjultilstand | SQ Modaliteti me dy rrota |
| ET Kahe ratta režiim | BS Režim rada na dva točka |
| LV Divu ritenū režīms | ME Režim rada na dva točka |
| LT Dviejų ratų režimas | MK Режим за две тркала |
| RU Двухколесный режим | HY Երկսկիւղի ռեժիմ |
| UK Двоколісний режим | VI Chế độ hai bánh xe |



 = 36

| | |
|-----------------------------------|-------------------------------------|
| EN Bumper bar | TR Tampon çubuğu |
| DE Schutzbügel | EL Μπάρα διάταξης προστασίας |
| ES Barra de seguridad | RO Bară de protecție |
| FR Barre de protection | IS Þverbiti |
| PT Barra de segurança | MT Strixxa tal-bumper |
| IT Barra paraurti | AR عارضة ممتص الصدمات |
| NL Veiligheidsbeugel | FA میله ضربهگیر |
| PL Pałak zabezpieczający | YUE 保險杠 |
| CS Dětské madlo | CMN 保險杠 |
| SK Dětská rúčka | JA バンパーバー |
| SL Varnostni lok | KO 범퍼 바 |
| HR Štitnik | BG Броня |
| HU Karfa | SR Štitnik |
| SE Stötfångare | MS Bar bumper |
| NO Fender | HI बम्पर बार |
| FI Suojakaari | TH แล่กันชน |
| DA Sikkerhedsbøjle | SQ Shufra e parakolpiti |
| ET Turvakaar | BS Štitnik |
| LV Aizsargloks | ME Štitnik |
| LT Amortizatoriaus strypas | MK Одбојник |
| RU Поручень | HY Թափարգել |
| UK Обмежувальний поручень | VI Thanh chống va đập |



 = 36

| | |
|---------------------------------|----------------------------------|
| EN Seat direction | TR Koltuk yönü |
| DE Sitzrichtung | EL Κατεύθυνση καθίσματος |
| ES Dirección de la silla | RO Direcție scaun |
| FR Sens du siège | IS Sætisstefna |
| PT Orientação do assento | MT Direzzjoni tas-sit |
| IT Direzione di seduta | AR اتجاه المقعد |
| NL Zitrichting | FA جهت صندلی |
| PL Kierunek siedzenia | YUE 座椅方向 |
| CS Směr sedadla | CMN 座椅方向 |
| SK Smer sedadla | JA シートの方向 |
| SL Smer sedeža | KO 좌석 방향 |
| HR Smjer sjedala | BG Посока на седалката |
| HU Ülészirány | SR Smer sedišta |
| SE Sitsriktning | MS Arah kerusi |
| NO Seteretning | HI सीट दिशा |
| FI Istumasuunta | TH ทิศทางที่นั่ง |
| DA Sæderetning | SQ Drejtimi i ndenjësës |
| ET Istme suund | BS Smjer sjedišta |
| LV Sēdekļa virziens | ME Smjer sjedišta |
| LT Kėdutės kryptis | MK Правец на седиште |
| RU Направление сиденья | HY Ստuhlուղիի ուղղություն |
| UK Напрямок сидіння | VI Hướng ghế ngồi |



 = 37

| | |
|-----------------------------|----------------------------------|
| EN Backrest | TR Arkalık |
| DE Rückenlehne | EL Πλάτη |
| ES Respaldo | RO Spătar |
| FR Dossier | IS Bak |
| PT Encosto de costas | MT Serh id-dahar |
| IT Schienale | AR مسند الظهر |
| NL Rugleuning | FA پشتی |
| PL Oparcie | YUE 靠背 |
| CS Opěradlo | CMN 靠背 |
| SK Operadlo | JA 背もたれ |
| SL Naslonjalo | KO 등받이 |
| HR Naslon | BG Облегалка |
| HU Háttámla | SR Naslon |
| SE Ryggstöd | MS Penyandar belakang |
| NO Rygglene | HI बैकरेस्ट |
| FI Selkänöja | TH หนักพิง |
| DA Ryglæn | SQ Mbështetësja e shpinës |
| ET Seljatugi | BS Naslon |
| LV Atzveltne | ME Naslon |
| LT Nugaros atlošas | MK Наслон за грб |
| RU Спинка | HY Թիկնակ |
| UK Спинка | VI Phấn tựa lưng |



= 37

| | | | |
|-----------|-------------------|------------|------------------------|
| EN | Legrest | TR | Bacak desteği |
| DE | Beinstütze | EL | Στήριγμα ποδιών |
| ES | Reposapiés | RO | Suport picior |
| FR | Repose-pieds | IS | Fótahvíla |
| PT | Apoio de pernas | MT | Serh is-saqajn |
| IT | Poggiagambe | AR | ميمدد الساق |
| NL | Beensteun | FA | جاپادی |
| PL | Podnózek | YUE | 腿托 |
| CS | Opěrka nohou | CMN | 腿托 |
| SK | Opierka nôh | JA | 足のせ |
| SL | Naslon za noge | KO | 다리받이 |
| HR | Naslon za noge | BG | Подложка за крака |
| HU | Lábtartó | SR | Naslon za noge |
| SE | Benstöd | MS | Tempat letak kaki |
| NO | Benstøtte | HI | लेगरेस्ट |
| FI | Jalkatuki | TH | ที่วางขา |
| DA | Benstøtte | SQ | Mbështetësja e këmbëve |
| ET | Jalatugi | BS | Naslon za noge |
| LV | Kāju balsts | ME | Naslon za noge |
| LT | Kojų atrama | MK | Наслон за носе |
| RU | Подставка для ног | HY | Ուղեքրի հեղման կտտ |
| UK | Опора для ніг | VI | Phàn tựa chân |



= 38

| | | | |
|-----------|--------------------------------|------------|-----------------------|
| EN | Sun canopy | TR | Güneş başlığı |
| DE | Sonnenverdeck | EL | Κουκούλα για τον ήλιο |
| ES | Capota para el sol | RO | Copertină |
| FR | Pare-soleil | IS | Sólartjald |
| PT | Capota solar | MT | Kopertura mix-xemx |
| IT | Parasole | AR | مظلة الشمس |
| NL | Zonnekap | FA | سایبان |
| PL | Oślona przeciwsłoneczna | YUE | 遮陽蓬 |
| CS | Stříška proti slunci | CMN | 遮阳蓬 |
| SK | Strieška proti slnku | JA | 日よけ力バー |
| SL | Senčnik za zaščito pred soncem | KO | 선 캐노피 |
| HR | Tenda za sunce | BG | Тента |
| HU | Kupola | SR | Tenda za sunce |
| SE | Solsufflett | MS | Kanopi matahari |
| NO | Solskjerm | HI | शुप छतरी |
| FI | Aurinkokatos | TH | หลังค้ำบังแดด |
| DA | Solkaleche | SQ | Strea për diellin |
| ET | Päikesevari | BS | Tenda za sunce |
| LV | Saules aizsegs | ME | Tenda za sunce |
| LT | Stogelis nuo saulės | MK | Стреа за сонце |
| RU | Солнцезащитный козырек | HY | Արևապաշտպան ծածկ |
| UK | Тент від сонця | VI | Mái che nắng |



| | |
|-----------|--------------------|
| EN | Handle bar |
| DE | Schiebegriff |
| ES | Manillar |
| FR | Poignée de poussée |
| PT | Guiador |
| IT | Manubrio |
| NL | Duwstang |
| PL | Uchwyt |
| CS | Madlo |
| SK | Rukoväť |
| SL | Ročaj |
| HR | Ručice |
| HU | Tolókar |
| SE | Handtag |
| NO | Håndtak |
| FI | Työntökahva |
| DA | Styr |
| ET | Sang |
| LV | Rokturis |
| LT | Rankena |
| RU | Рукоятка |
| UK | Рукоятка |

| | |
|------------|------------------|
| TR | Tutma sapı |
| EL | Ράβρος λαβής |
| RO | Mâner |
| IS | Handfang |
| MT | Handle bar |
| AR | عارضة المقبض |
| FA | میله دسته |
| YUE | 把手 |
| CMN | 把手 |
| JA | ハンドルパー |
| KO | 핸들 바 |
| BG | Кормило |
| SR | Ručke |
| MS | Bar pemegang |
| HI | हैंडल बार |
| TH | ด้ามจับ |
| SQ | Shufra e dorezës |
| BS | Ručice |
| ME | Ručke |
| MK | Рачка |
| HY | Վաղափարման բռնակ |
| VI | Tay cầm |

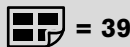

| | | | |
|-----------|-------------------------|------------|----------------------------|
| EN | Swivel locks | TR | Tekerlek kilidi |
| DE | Schwenkradsperre | EL | Περιστροφόμενες κλειδαριές |
| ES | Bloqueos de dirección | RO | Încuietori pivotante |
| FR | Verrous pivotants | IS | Snúningslásar |
| PT | Bloqueios de rotação | MT | Lokks li jduru |
| IT | Blocchi girevoli | AR | أقفال دوران العجلات |
| NL | Zwenkvergrendeling | FA | قفل های نوسان |
| PL | Blokada obrotu | YUE | 旋轉鎖 |
| CS | Aretační zámky | CMN | 旋轉鎖 |
| SK | Aretačné zámky | JA | 回転ロック |
| SL | Blokada vrtenja | KO | 회전 잠금장치 |
| HR | Zaključavanje okretanja | BG | Завъртащи се ключалки |
| HU | Beállás-zár | SR | Zakretni mehanizmi |
| SE | Vridlås | MS | Kunci ayun |
| NO | Svingelåser | HI | कुंडा ताले |
| FI | Kääntölukko | TH | ตัวล็อกแบบหมุน |
| DA | Drejelås | SQ | Kuçja e rrotave |
| ET | Pöördlukustus | BS | Zakretni mehanizmi |
| LV | Rotācijas bloķētāji | ME | Zakretni mehanizmi |
| LT | Šarnyriniai fiksatoriai | MK | Заклучување на тркалата |
| RU | Блокировки вращения | HY | Պտտվողի կողպիչներ |
| UK | Замок шарніра | VI | Khóa xoay |

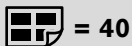

= 40

| | | | |
|-----------|-----------------------|------------|--------------------------|
| EN | Removing the wheels | TR | Tekerlekleri çıkarma |
| DE | Entfernen der Räder | EL | Αφαίρεση των τροχών |
| ES | Quitar las ruedas | RO | Îndepărtarea roților |
| FR | Retrait des roues | IS | Fjarlægja hjól |
| PT | Remover as rodas | MT | Tneħħija tar-roti |
| IT | Rimozione delle ruote | AR | فك العجلات |
| NL | De wielen verwijderen | FA | باز کردن چرخ‌ها |
| PL | Zdejmowanie kółek | YUE | 拆卸車輪 |
| CS | Odstranění koleček | CMN | 拆卸车轮 |
| SK | Odstránenie koliesok | JA | 車輪の取り外し |
| SL | Odstranjevanje koles | KO | 휠 제거 |
| HR | Uklanjanje kotača | BG | Демонтиране на колелата |
| HU | Kerekek eltávolítása | SR | Uklanjanje točkova |
| SE | Ta bort hjulen | MS | Menanggalkan roda |
| NO | Fjerne hjulene | HI | फहियों को हटाना |
| FI | Pyörien poisto | TH | การถอดล้อ |
| DA | Fjernelse af hjulene | SQ | Heqja e rrotave |
| ET | Rataste eemaldamine | BS | Uklanjanje točkova |
| LV | Riteņu atvienošana | ME | Uklanjanje točkova |
| LT | Ratų nuėmimas | MK | Отстранување на тркалата |
| RU | Снятие колес | HY | Անհիվանելը հասելը |
| UK | Зняття коліс | VI | Tháo bánh xe |

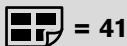

= 41

| | | | |
|-----------|------------------------|------------|----------------------------|
| EN | Removing the fabric | TR | Kılıfı çıkarma |
| DE | Entfernen des Bezuges | EL | Αφαίρεση του υφάσματος |
| ES | Quitar la tela | RO | Îndepărtarea țesăturii |
| FR | Retrait du tissu | IS | Fjarlægja efni |
| PT | Remover o tecido | MT | Tneħħija tad-drapp |
| IT | Rimozione del tessuto | AR | فك القماش |
| NL | De stof verwijderen | FA | برداشتن پارچه |
| PL | Zdejmowanie pokrycia | YUE | 拆除罩布 |
| CS | Odstranění látky | CMN | 拆除罩布 |
| SK | Odstránenie látky | JA | カバーの取り外し |
| SL | Odstranjevanje blaga | KO | 페브릭 제거 |
| HR | Uklanjanje tkanine | BG | Демонтиране на плата |
| HU | Huzat eltávolítása | SR | Uklanjanje tkanine |
| SE | Ta bort tyget | MS | Menanggalkan fabrik |
| NO | Fjerne stoffet | HI | कपड़ा हटाना |
| FI | Kankaan poisto | TH | การถอดผ้า |
| DA | Fjernelse af stoffet | SQ | Heqja e copës |
| ET | Kanga eemaldamine | BS | Uklanjanje tkanine |
| LV | Pārklājuma atvienošana | ME | Uklanjanje tkanine |
| LT | Audinio nuėmimas | MK | Отстранување на навлакмата |
| RU | Снятие ткани | HY | Գործվածքը հանելը |
| UK | Зняття матерії | VI | Tháo phần vải bọc |

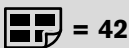

= 42

| | | | |
|-----------|---------------------------|------------|--------------------|
| EN | Carry Cot | TR | Portbebe |
| DE | Kinderwagenaufsatz | EL | Πορτ-μπεμπέ |
| ES | Capazo | RO | Landou portabil |
| FR | Navelle bébé | IS | Burðarrúm |
| PT | Alcofa | MT | Carry Cot |
| IT | Culla portatile | AR | سرير محمول |
| NL | Zitbak | FA | ساک حمل نوزاد |
| PL | Gondola wózka dziecięcego | YUE | 便攜嬰兒床 |
| CS | Hluboká korba | CMN | 便携嬰兒床 |
| SK | Korba na prenášanie | JA | 持ち運びベッド |
| SL | Nosilna košara | KO | 캐리콧 |
| HR | Ležaljka za prenošenje | BG | Легло за носене |
| HU | Mózeskosár | SR | Dodatak za kolica |
| SE | Barnvagnslift | MS | Katil Bayi Bimbit |
| NO | Babybag | HI | कैरी कॉट |
| FI | Kantolaukku | TH | ตะกร้าที่นอนเด็ก |
| DA | Babylift | SQ | Djep |
| ET | Vankrikorv | BS | Dodatak za kolica |
| LV | Bērnu gultīņa | ME | Dodatak za kolica |
| LT | Nešiojamasis lopšys | MK | Кошница за носење |
| RU | Переносная люлька | HY | Սանկալակն շարժական |
| UK | Переносне дитяче ліжечко | VI | Nôi xách tay |

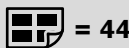

= 44

| | | | |
|-----------|--------------------------------|------------|----------------------------------|
| EN | Infant Car Seat | TR | Bebek Araba Koltuğu |
| DE | Babyschale | EL | Παιδικό κάθισμα αυτοκινήτου |
| ES | Silla infantil para coche | RO | Scaunul auto pentru infant |
| FR | Siège auto pour enfant | IS | Smábarnabílstóll |
| PT | Cadeira auto infantil | MT | Sit tal-Karozza tat-Tfal |
| IT | Seggiolino per auto | AR | مقعد سيارة للرضع |
| NL | Autostoeltje | FA | صندلی خودرو برای نوزاد |
| PL | Fotelik dla niemowlaka | YUE | 嬰兒汽車座椅 |
| CS | Vajíčko | CMN | 婴儿汽车座椅 |
| SK | Autosedáčka pre dojčatá | JA | 幼児用カーシート |
| SL | Avtosedež za dojenčke | KO | 유아용 카시트 |
| HR | Autosjedalica za bebe | BG | Бебешка седалка за автомобил |
| HU | Gyermek autósülés | SR | Auto sedište za bebe |
| SE | Bilbarnstol | MS | Kerusi Keselamatan Bayi |
| NO | Barnebilsete | HI | शिशु कार सीट |
| FI | Lasten istuin | TH | คาร์ซีทสำหรับเด็กทารก |
| DA | Autostol | SQ | Sexholino |
| ET | Imiku turvatool | BS | Auto sjedište za bebe |
| LV | Zīdaiņu sēdekļis | ME | Auto sjedište za bebe |
| LT | Automobilinė naujagimio kėdutė | MK | Детско седиште за автомобил |
| RU | Детское автокресло | HY | Սկստանդարտայի սանկալակն նստատեղի |
| UK | Автокрісло для немовлят | VI | Ghế xe dành cho trẻ sơ sinh |

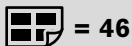

| | | | |
|-----------|------------------------|------------|-----------------------|
| EN | Rain cover | TR | Yağmurluk |
| DE | Regenverdeck | EL | Καλύπτρα βροχής |
| ES | Funda para la lluvia | RO | Prelată de ploaie |
| FR | Housse de pluie | IS | Regn yfirbreiðsla |
| PT | Capa de chuva | MT | Għata mix-xita |
| IT | Parapioggia | AR | غطاء المطر |
| NL | Regenhoes | FA | روکش باران |
| PL | Oslona od deszczu | YUE | 防雨罩 |
| CS | Pláštěnka | CMN | 防雨罩 |
| SK | Kryt proti dažďu | JA | 雨よけ |
| SL | Dežna prevleka | KO | 레인커버 |
| HR | Pokrivač za kišu | BG | Дъждобран |
| HU | Esővédő | SR | Pokrivač za kišu |
| SE | Regnskydd | MS | Pelindung hujan |
| NO | Kalesje | HI | रेन कवर |
| FI | Sadesuoja | TH | ผ้าคลุมกันฝน |
| DA | Regnslag | SQ | Mbulesë për shiun |
| ET | Vihmakate | BS | Pokrivač za kišu |
| LV | Pretlietus pārvalks | ME | Pokrivač za kišu |
| LT | Uždangalas nuo lietaus | MK | Прекривка за дожд |
| RU | Дождевик | HY | Անձրևապաշտպան ծածկ |
| UK | Дощовик | VI | Tấm che mưa |

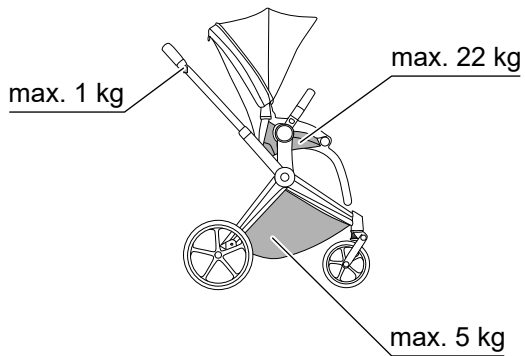

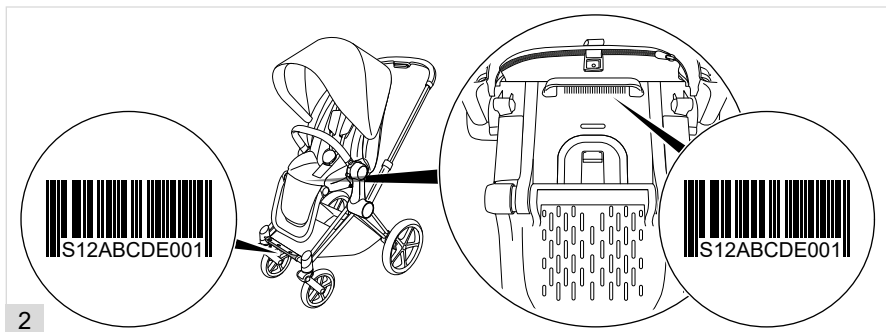
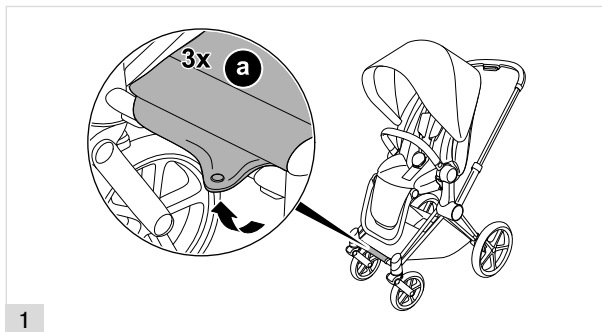

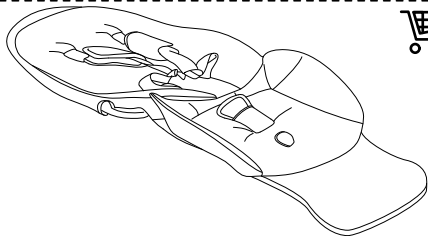
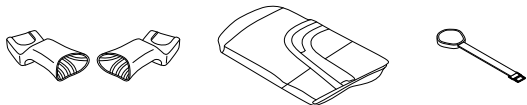
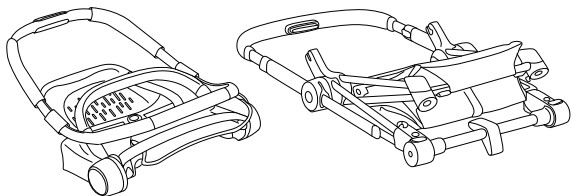

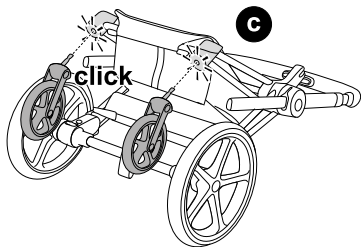
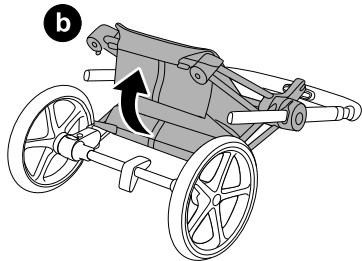
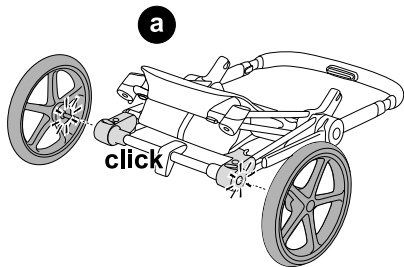

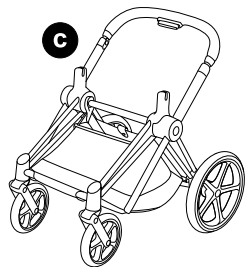
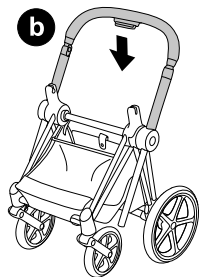
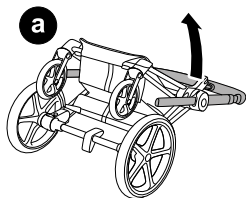

3

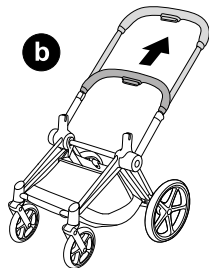
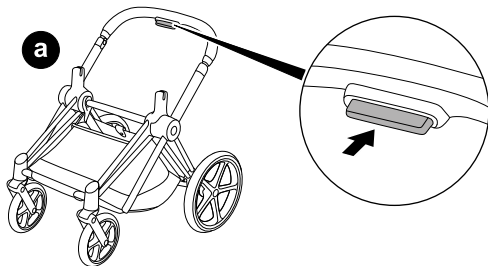

4

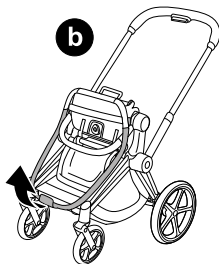
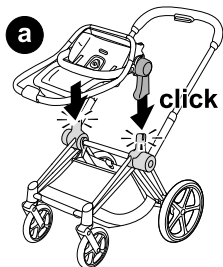

5

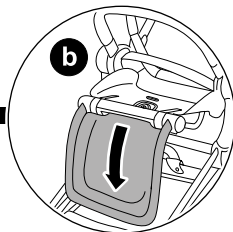
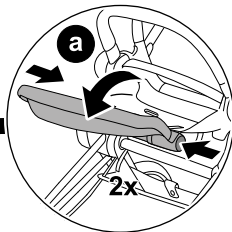
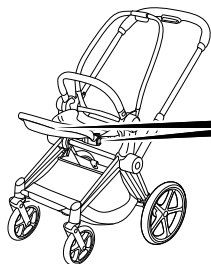

6

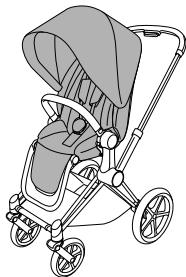

7

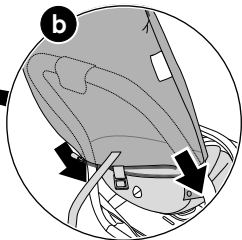
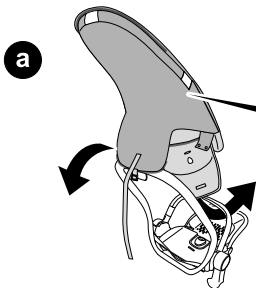

20

8

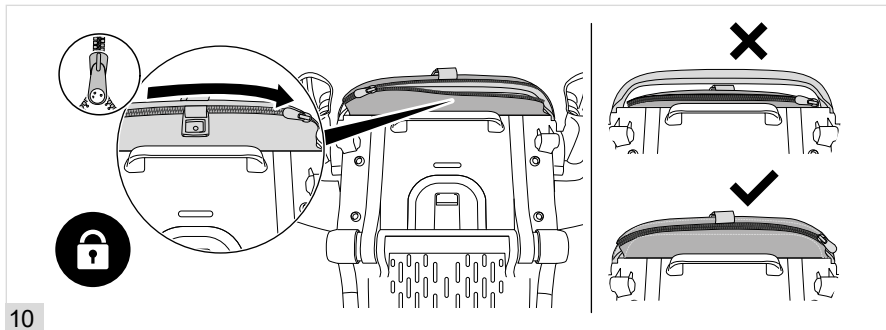
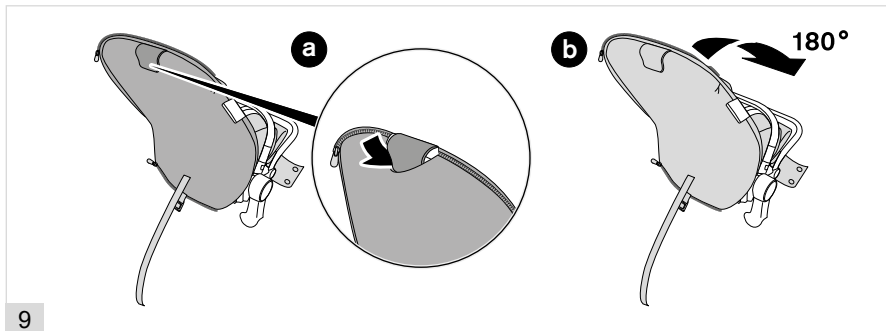

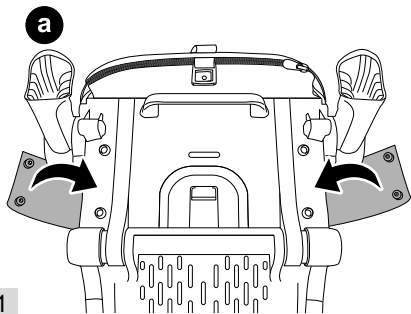

11

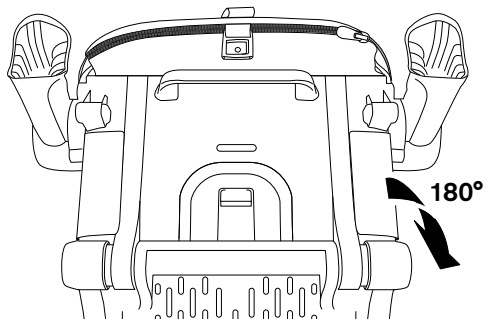
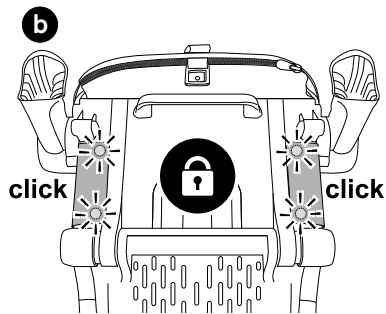

12

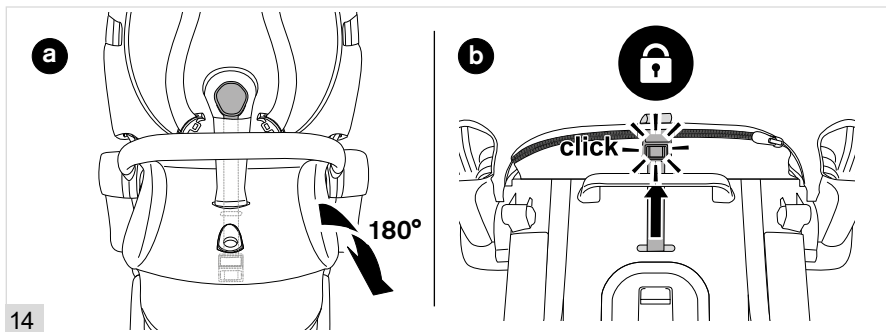
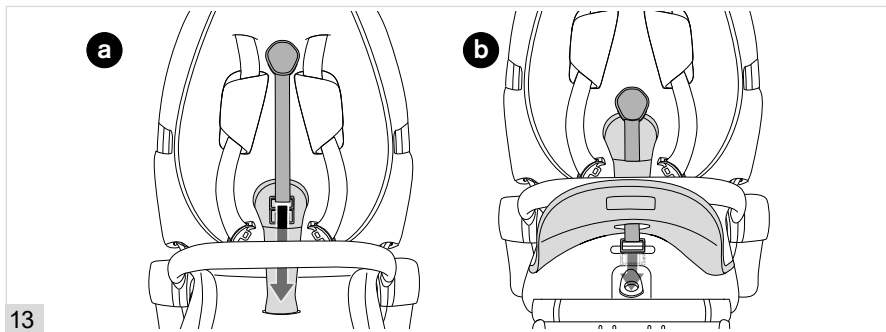

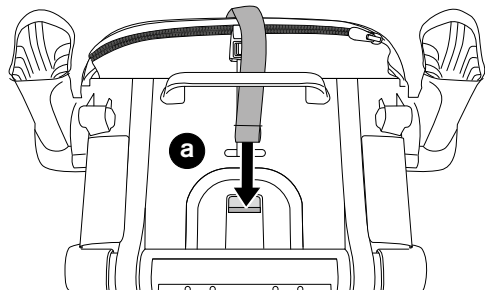

15

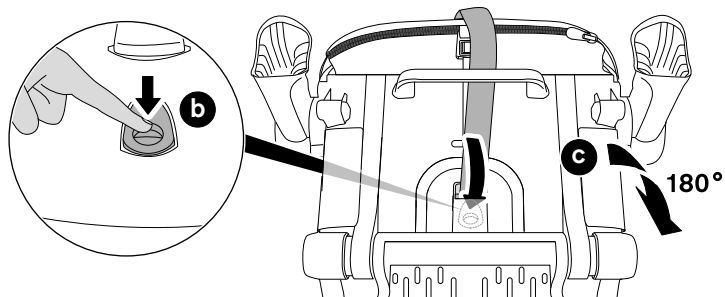

24

16

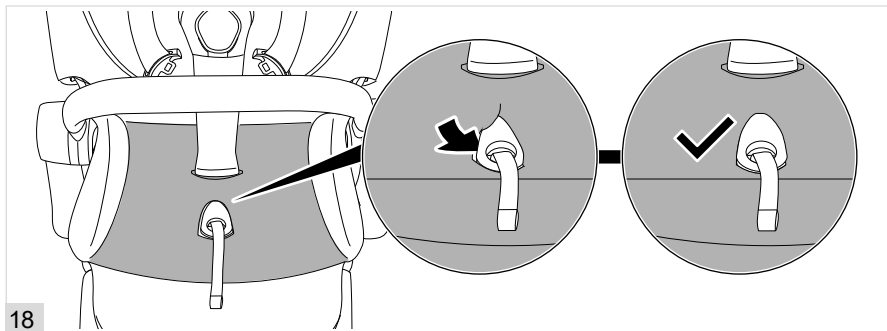
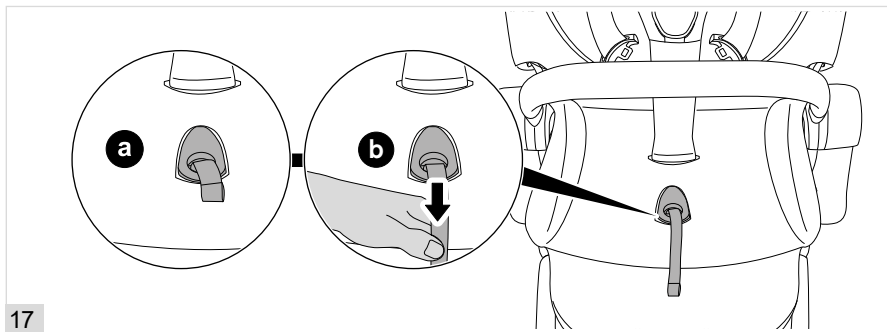

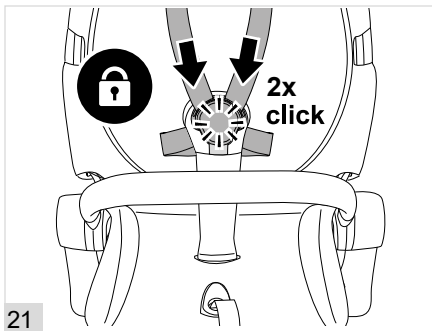
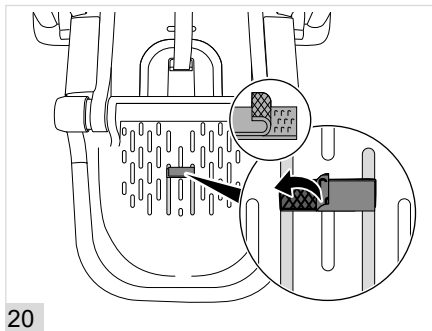
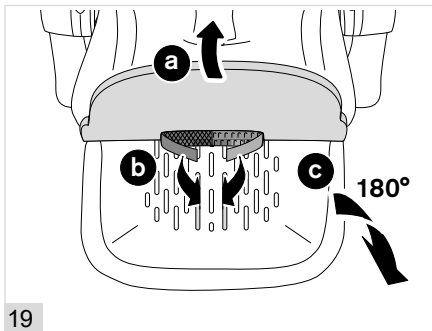

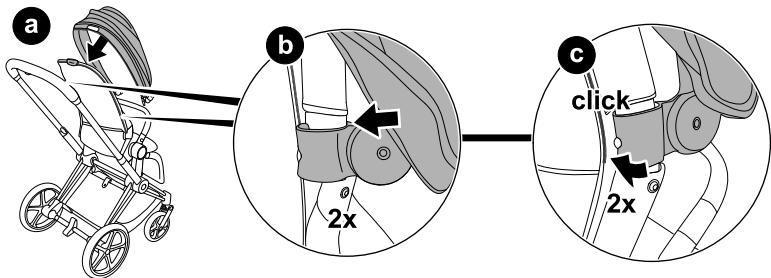

23

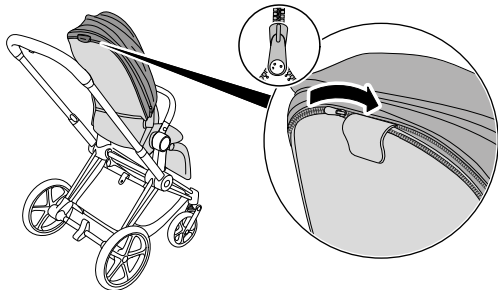

24

27

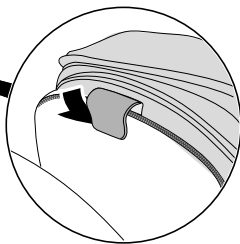
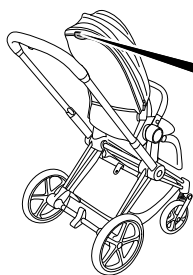

25

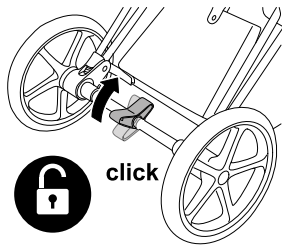

click

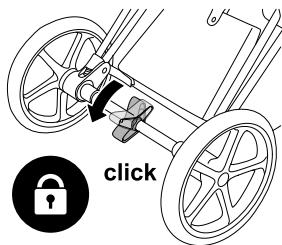

click

1

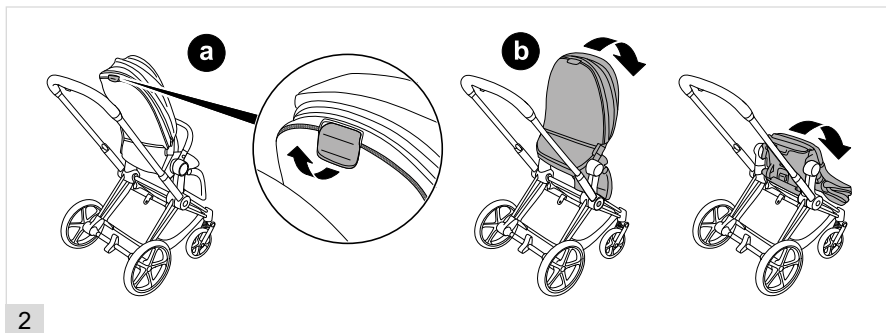
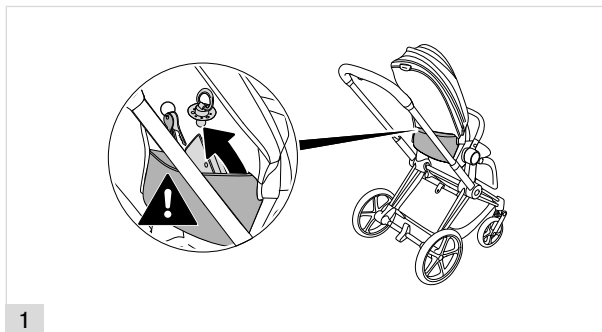

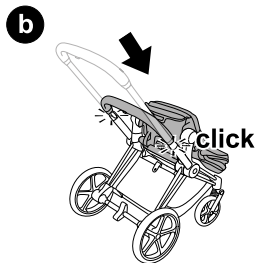
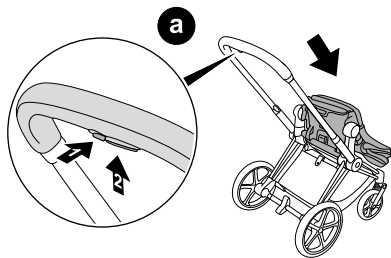

3

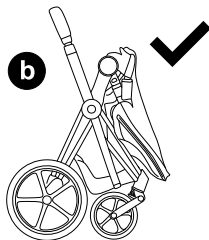
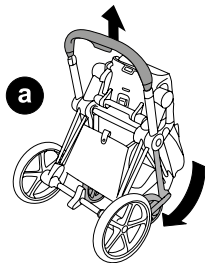

30

4

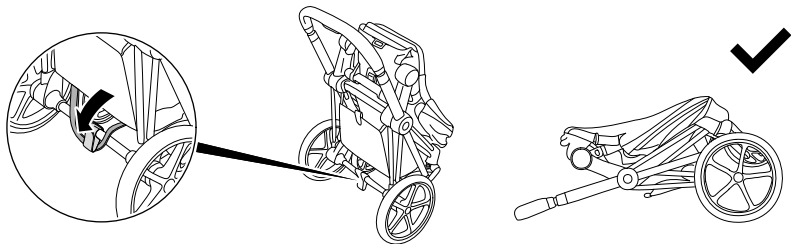

5

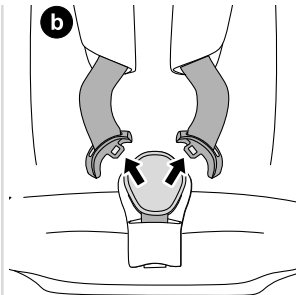
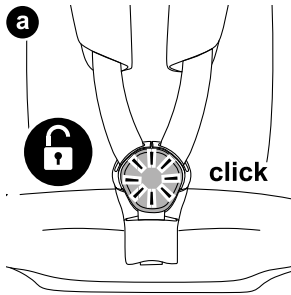

1



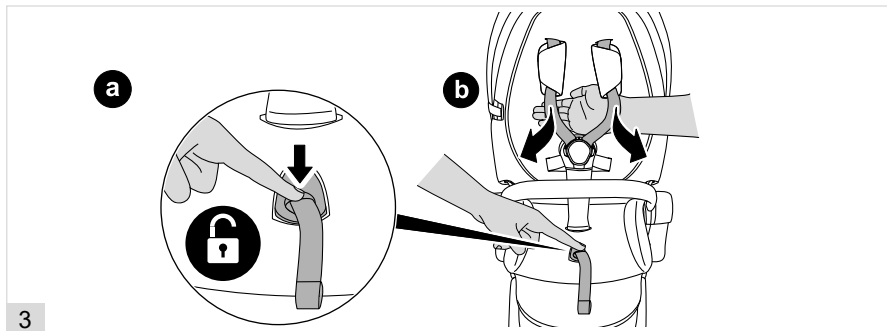
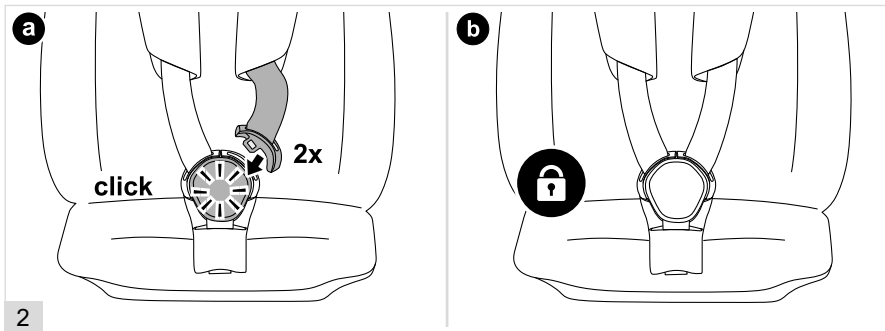

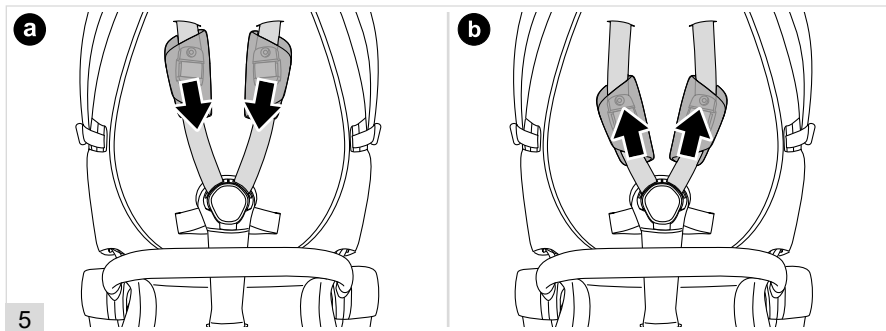
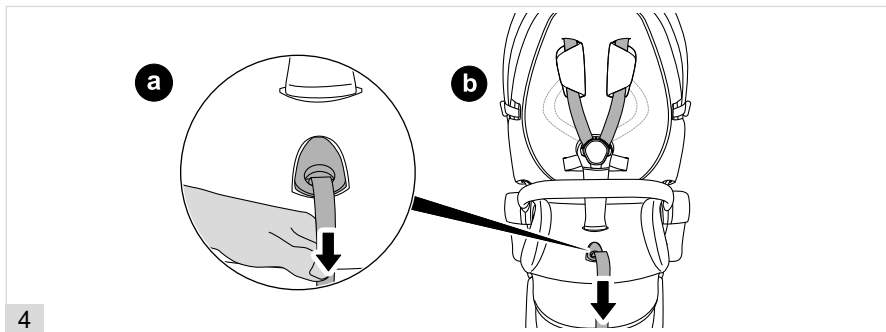

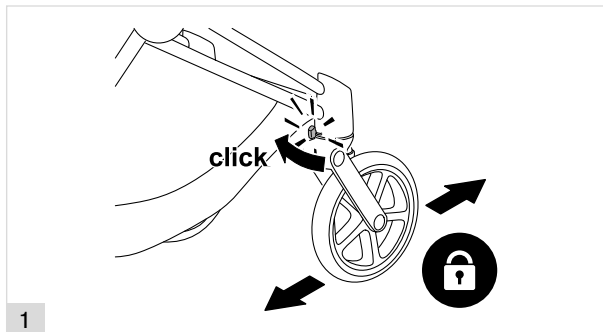
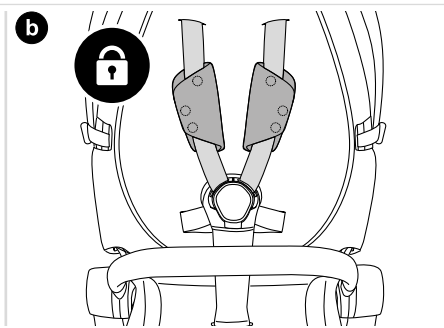
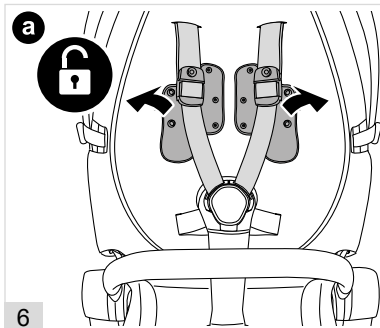

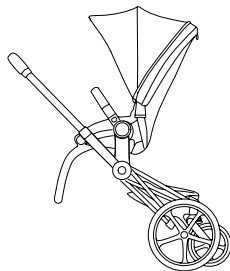
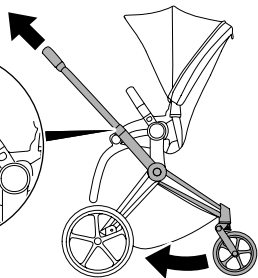
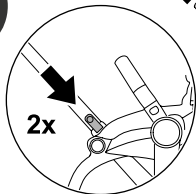

2

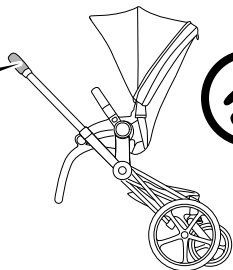
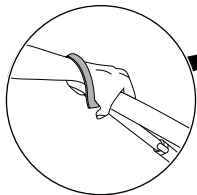

3

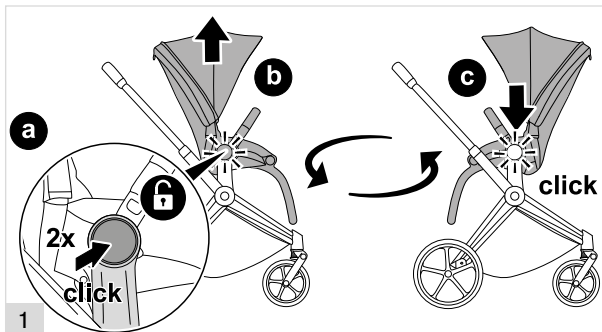
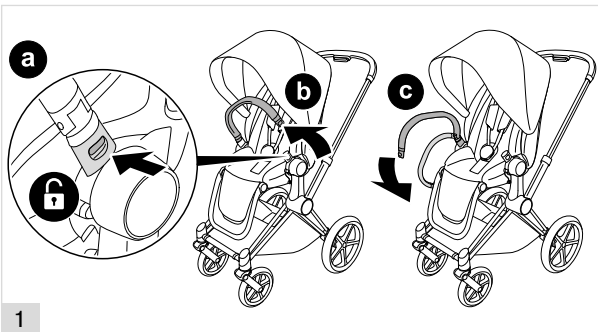

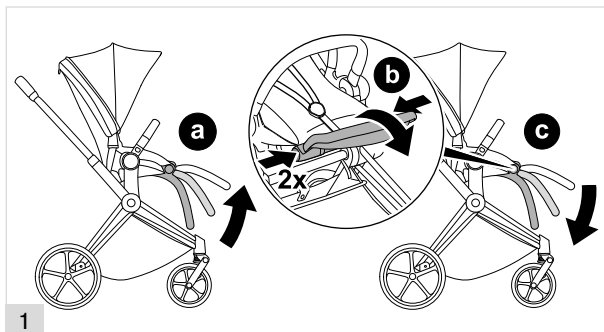
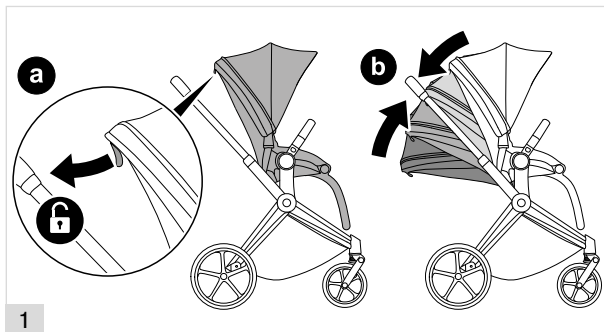



1

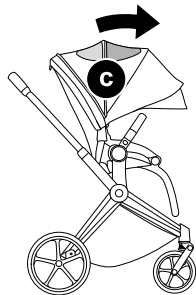
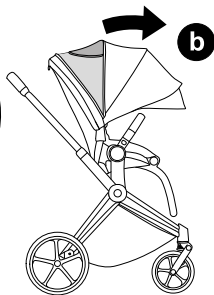
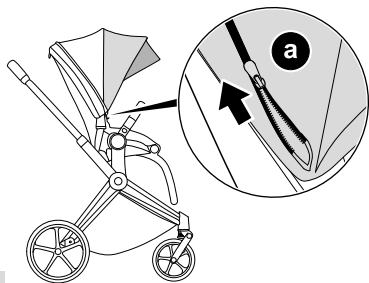
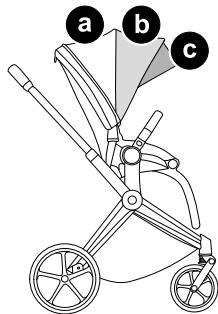
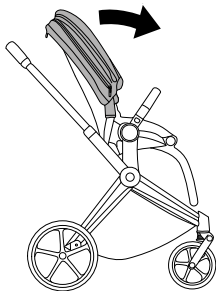

38

2

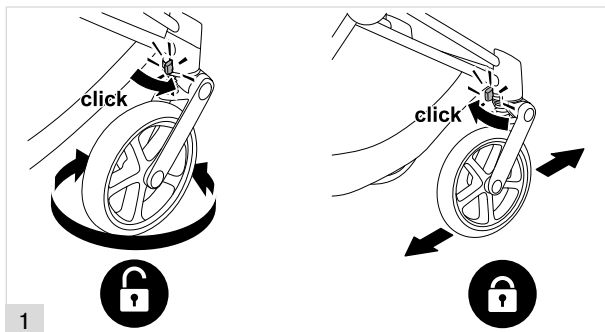
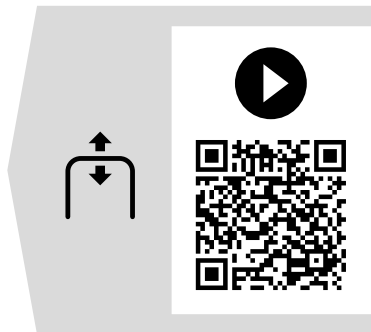
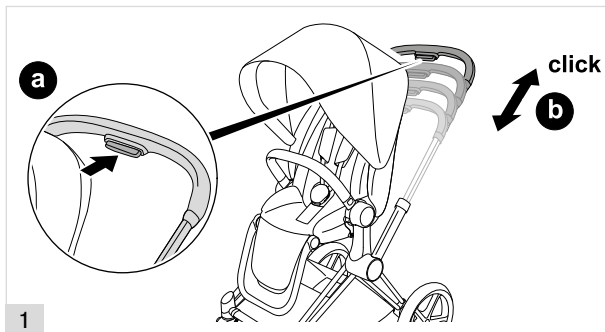

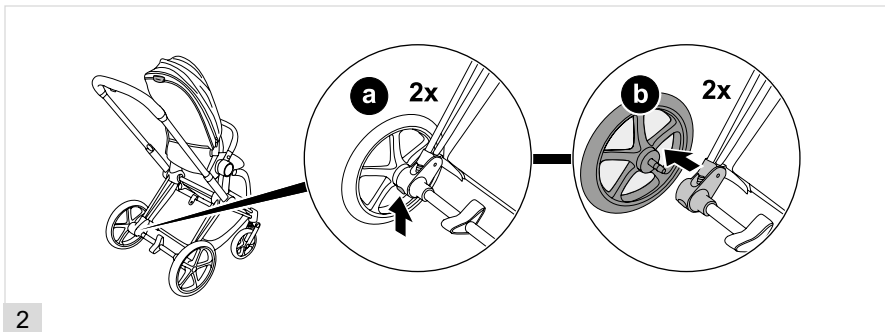
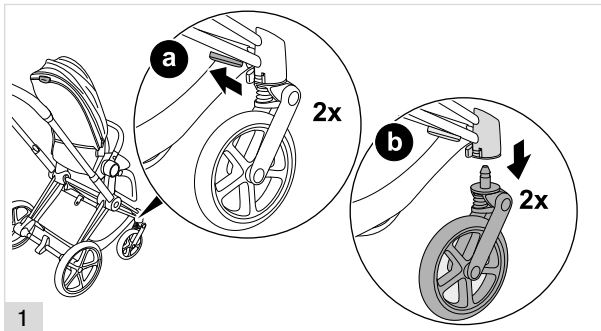

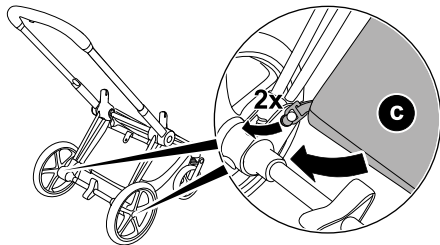
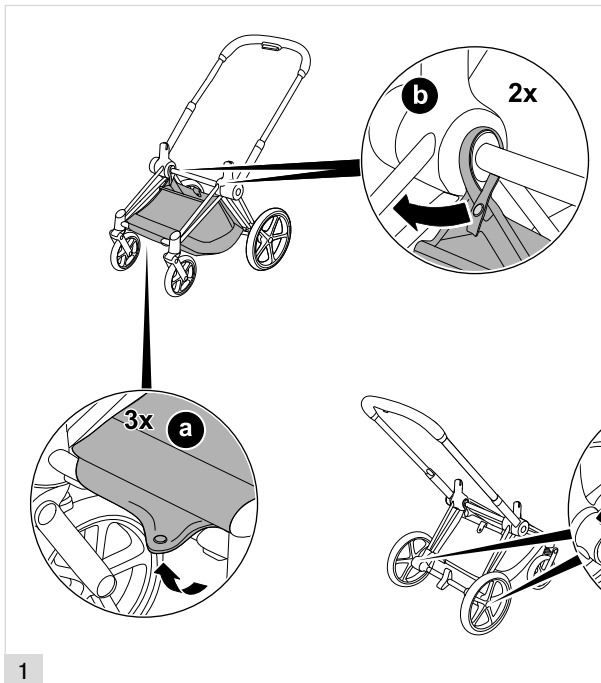

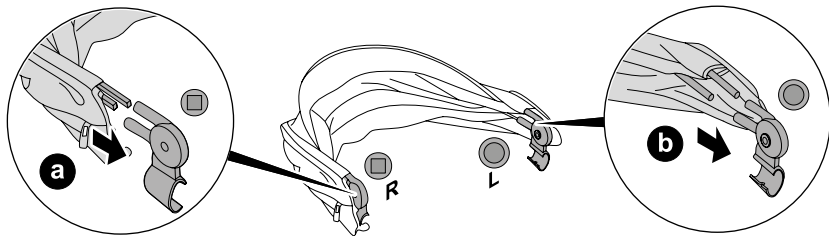

2

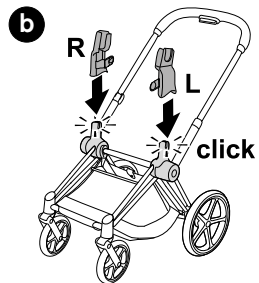
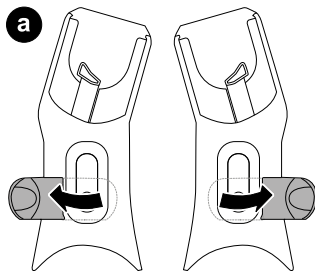

1



C

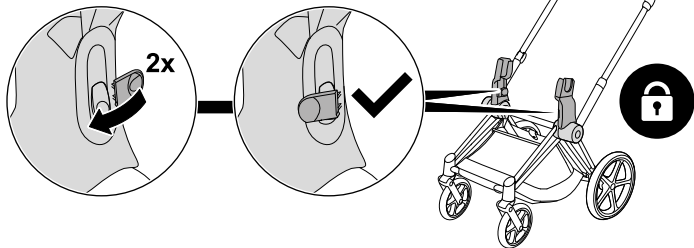

2

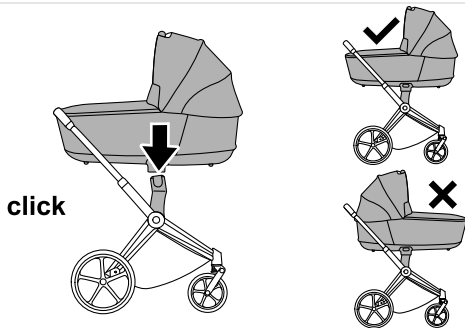

3

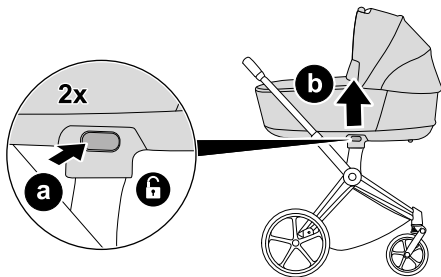

4

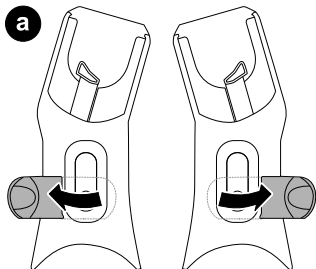

1

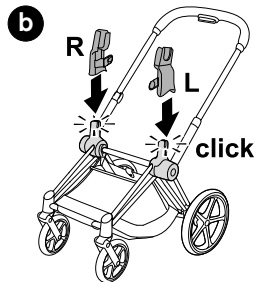



C

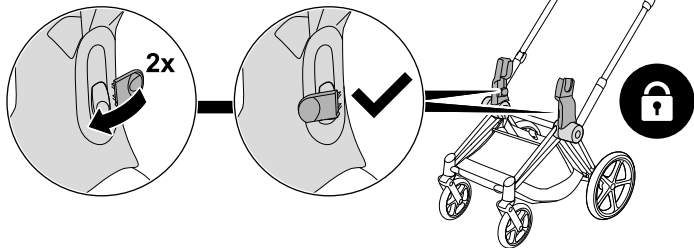

2

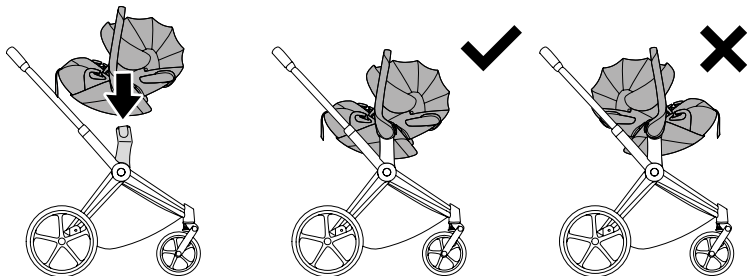

3

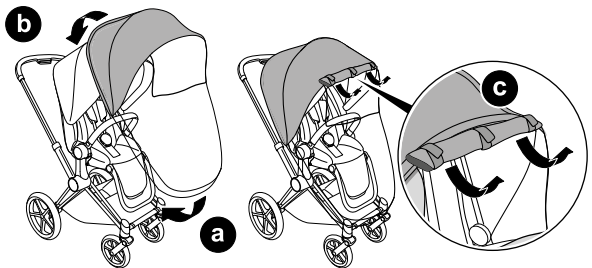

1



CYBEX GmbH
Riedingerstr. 18 | 95448 Bayreuth | Germany
+49 (0) 921-78 511-0 | info@cybex-online.com
www.cybex-online.com

