

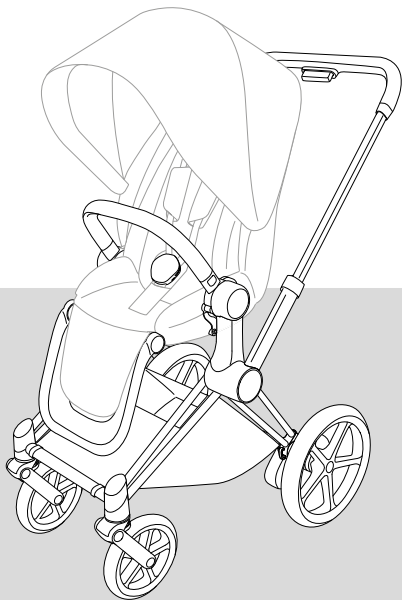

e·PRIAM
FRAME & SEAT





EN WARNING
DE WARNUNG
ES ADVERTENCIA
FR AVERTISSEMENT
PT AVISOS
IT WARNING
NL WAARSCHUWING
PL OSTRZEŻENIE
CS UPOZORNĚNÍ
SK UPOZORNENIE
SL OPOZORILO
HR UPOZORENJE
HU FIGYELMEZTETÉS
SE VARNING
NO ADVARSEL
FI VAROITUS
DA ADVARSEL
ET HOIATUS
LV BRĪDINĀJUMS
LT PERSPĖJIMAS
RU ВНИМАНИЕ
UK УВАГА
TR UYARI
EL ΠΡΟΕΙΔΟΠΟΙΗΣΗ
RO AVERTISMENTE
IS VIÐVÖRUN
MT TWISSIJA

AR
FA
YUE 警告
CMN 警告
JA 警告
KO 경고
BG ПРЕДУПРЕЖДЕНИЕ
SR UPOZORENJE
MS AMARAN
HI चेतावनी
TH คำเตือน
SQ PARALAJMËRIM
BS UPOZORENJE
ME UPOZORENJE
MK ПРЕДУПРЕДУВАЊЕ
HY շֆԻՇԱՅՈՒՄ
VI CẢNH BÁO

تحذير
اخطار



EN Tutorial video
DE Videoanleitung
ES Tutorial en vídeo
FR Vidéo de démonstration
PT Video tutorial
IT Video tutorial
NL Instructievideo
PL Film instruktażowy
CS Výukové video
SK Výukové video
SL Video z navodili
HR Video s uputama
HU Bemutatóvideó
SE Videosjälvstudiekurs
NO Opplæringsvideo
FI Opetusvideo
DA Vejledende video
ET Õppevideo
LV Ar mācību video
LT Mokomasis vaizdo įrašas
RU Обучающее видео
UK Навчальне відео
TR Öğretici video
EL Εκπαιδευτικό βίντεο
RO Video tutorial
IS Kennslumyndband
MT Tutorial fuq vidjow

AR
FA
YUE 教程視頻
CMN 教程视频
JA チュートリアルビデオ
KO 튜토리얼 동영상
BG Учебно видео
SR Video sa uputstvima
MS Video tutorial
HI ट्यूटोरियल वीडियो
TH วิดีโอแนะนำ
SQ Video udhëzuese
BS Video sa uputstvima
ME Video sa uputstvima
MK Видеоупатство
HY Πλατύνει οδηγίες με τη βοήθεια ηχητικού
VI Video hướng dẫn

فيديو تعليمي
ويدئوى آموزشى

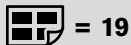

EN Maximum weights
DE Maximalgewichte
ES Pesos máximos
FR Poids maximum
PT Pesos máximos
IT Peso massimo
NL Maximumgewicht
PL Dopuszczalna waga
CS Maximální hmotnosti
SK Maximálne hmotnosti
SL Največje teže
HR Maksimalne težine
HU Maximális súlyok
SE Max.vikter
NO Maksimumsvektor
FI Enimmäispainot
DA Maksimumvægt
ET Maksimaalne kaal
LV Maksimālais svars
LT Didžiausi svoriai
RU Максимальная масса
UK Максимальна вага

TR Maksimum ağırlıklar
EL Μέγιστο βάρος
RO Greutăți maxime
IS Hámarksþyngd
MT Piżijiet massimi
AR الأوزان القصوى
FA حداکثر وزن
YUE 最大重量
CMN 最大重量
JA 最大重量
KO 최대 하중
BG Максимални тегла
SR Maksimalne težine
MS Berat maksimum
HI अधिकतम वजन
TH น้ำหนักสูงสุด
SQ Peshat maksimale
BS Maksimalne težine
ME Maksimalne težine
MK Максимални тежини
HY Առավելագույն քաշեր
VI Các mức cân nặng tối đa

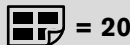

EN Product registration
DE Produktregistrierung
ES Registro del producto
FR Enregistrement du produit
PT Registo do produto
IT Registrazione del prodotto
NL Productregistratie
PL Rejestracja produktu
CS Registrace výrobku
SK Registrácia výrobku
SL Registracija izdelka
HR Registracija proizvoda
HU Termékregisztráció
SE Produktregistrering
NO Produktregistrering
FI Tuotteen rekisteröinti
DA Produktregistrering
ET Toote registreerimine
LV Produkta reģistrācija
LT Gaminio registracija
RU Регистрация продукта
UK Реєстрація продукту

TR Ürün kaydı
EL Καταχώριση προϊόντος
RO Înregistrarea produsului
IS Skráning tækis
MT Reġistrazzjoni tal-prodott
AR تسجيل المنتج
FA ثبت محصول
YUE 產品註冊
CMN 产品注册
JA 製品の登録
KO 제품 등록
BG Регистрация на продукта
SR Registracija proizvoda
MS Pendaftaran produk
HI उत्पाद पंजीकरण
TH การลงทะเบียนผลิตภัณฑ์
SQ Regjistrimi i produktit
BS Registracija proizvoda
ME Registracija proizvoda
MK Регистрација на производ
HY Արձանագր գրանցում
VI Đăng ký sản phẩm

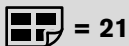

= 21

EN	Set up	TR	Kurulum
DE	Aufbau	EL	Στήσιμο
ES	Instalación	RO	Setare
FR	Montage	IS	Uppsetning
PT	Preparação	MT	Konfigurazzjoni
IT	Configurazione	AR	تنصيب
NL	Opbouw	FA	برپا کردن
PL	Montaż	YUE	設置
CS	Nastavení	CMN	设置
SK	Nastavenie	JA	セットアップ
SL	Nastavitev	KO	설정
HR	Postavljanje	BG	Настройка
HU	Felszerelés	SR	Postavljanje
SE	Inställning	MS	Persediaan
NO	Oppsett	HI	सेट अप
FI	Asennus	TH	การติดตั้ง
DA	Opsætning	SQ	Konfigurimi
ET	Seadistamine	BS	Postavljanje
LV	Uzstādīšana	ME	Postavljanje
LT	Nuostatos	MK	Поставување
RU	Установка	HY	Շարժափոխում
UK	Встановлення	VI	Cài đặt

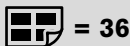

= 36

EN	Battery	TR	Batarya
DE	Batterie	EL	Μπαταρία
ES	Batería	RO	Baterie
FR	Pile	IS	Rafhlaða
PT	Bateria	MT	Batterija
IT	Batteria	AR	بطارية
NL	Batterij	FA	باتری
PL	Bateria	YUE	電池
CS	Baterie	CMN	电池
SK	Batéria	JA	バッテリー
SL	Baterija	KO	배터리
HR	Baterija	BG	Батерия
HU	Elem	SR	Baterija
SE	Batteri	MS	Bateri
NO	Batteri	HI	बैटरी
FI	Paristo	TH	แบตเตอรี่
DA	Batteri	SQ	Bateria
ET	Aku/patarei	BS	Baterija
LV	Baterija	ME	Baterija
LT	Akumulatorius	MK	Батерија
RU	Батарея	HY	Սարքսկղն
UK	Акумулятор	VI	Pin

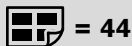

EN	Turning on and off	TR	Açıp Kapatma
DE	Ein- und Ausschalten	EL	Ενεργοποίηση και απενεργοποίηση
ES	Encender y apagar	RO	Pornirea și oprirea
FR	Allumer et éteindre	IS	Kveikja og slökkva
PT	Ligar e desligar	MT	Ixgħel u ifi
IT	Accensione e spegnimento	AR	تشغيل وإيقاف
NL	Aan- en uitschakelen	FA	خاموش و روشن کردن
PL	Włączanie i wyłączenie	YUE	打開和關閉
CS	Zapnutí a vypnutí	CMN	打开和关闭
SK	Zapnutie a vypnutie	JA	オン/オフの切り替え
SL	Vklop in izklop	KO	켜고 끄기
HR	Uključivanje i isključivanje	BG	Включване и изключване
HU	Ki- és bekapcsolás	SR	Uključivanje i isključivanje
SE	Slå på och stänga av	MS	Menghidupkan dan mematikan
NO	Slå på og av	HI	चालू और बंद करना
FI	Käynnistys ja sammutus	TH	การเปิดและปิด
DA	Tænd og sluk	SQ	Ndezja dhe fikja
ET	Sisse- ja väljalülitamine	BS	Uključivanje i isključivanje
LV	Ieslēgšana un izslēgšana	ME	Uključivanje i isključivanje
LT	Ijungimas ir išjungimas	MK	Включвање и исклучвање
RU	Включение и выключение	HY	Միացնելը և անջատելը
UK	Увімкнення та вимкнення	VI	Bật và tắt

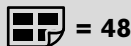

EN	App	TR	Uygulama
DE	App	EL	Εφαρμογή
ES	Aplicación	RO	Aplicatie
FR	Appli	IS	Smáforrit
PT	Aplicação	MT	App
IT	App	AR	تطبيق
NL	App	FA	برنامه
PL	Aplikacja	YUE	應用
CS	Aplikace	CMN	应用
SK	Aplikácia	JA	アプリ
SL	Aplikacija	KO	앱
HR	App	BG	Приложение
HU	App	SR	Aplikacija
SE	App	MS	Aplikasi
NO	App	HI	ऐप
FI	App	TH	แอป
DA	App	SQ	Aplikacion
ET	Rakendus	BS	App
LV	Lietotne	ME	App
LT	Programėlė	MK	Апликација
RU	Приложение	HY	Հավելված
UK	Додаток	VI	Ứng dụng



 = 50

EN	Rocking feature	TR	Sallama özelliği
DE	Schaukelfunktion	EL	Λειτουργία λικνίσματος
ES	Función de balanceo	RO	Funcție de legănare
FR	Fonction basculante	IS	Aðstoð við að rugga
PT	Funcionalidade de embalo	MT	Karatteristika għat-tbennin
IT	Funzione dondolo	AR	خاصية التآرجح
NL	Schommelfunctie	FA	قابلیت حرکت گهواره‌ای
PL	Funkcja kołysania	YUE	搖擺特徵
CS	Funkce houpaní	CMN	摇摆特征
SK	Funkcia hojdanía	JA	ゆりかご機能
SL	Lastnost zibanja	KO	락킹 기능
HR	Funkcija ljuljanja	BG	Функция за люлеене
HU	Ringató funkció	SR	Funkcija ljuljanja
SE	Vaggningfunktion	MS	Ciri mengayun
NO	Vuggefunksjon	HI	हिलाने-डुलाने की सुविधा
FI	Keinutoiminto	TH	คุณสมบัติการโยก
DA	Vuggefunktion	SQ	Veçoria e lëkundjeve
ET	Kiigefunktsioon	BS	Funkcija ljuljanja
LV	Šūpošanās funkcija	ME	Funkcija ljuljanja
LT	Sūravimo funkcija	MK	Функција за лулање
RU	Функция качания	HY	ճոճման ԼճԺԺ
UK	Функція гойдання	VI	Tính năng đu đưa



 = 51

EN	Hands positioning	TR	Ellerin pozisyonu
DE	Positionierung der Hände	EL	Τοποθέτηση χεριών
ES	Posicionamiento de las manos	RO	Poziționarea mâinilor
FR	Positionnement des mains	IS	Handstaða
PT	Posicionamento das mãos	MT	Požizzjonar tal-idejn
IT	Posizionamento delle mani	AR	موضع اليدين
NL	Positionering van de handen	FA	موقعیت دست‌ها
PL	Pozycja rąk	YUE	雙手定位
CS	Umístění rukou	CMN	双手定位
SK	Umiestnenie rúk	JA	手の位置
SL	Postavitve rok	KO	손잡이 위치
HR	Pozicioniranje ruku	BG	Разположение на ръцете
HU	Kezek elhelyezése	SR	Pozicioniranje ruku
SE	Positionering av händer	MS	Perletakan tangan
NO	Håndplassering	HI	हैंड पोजिशनिंग
FI	Käsien sijoittaminen	TH	การกำหนดตำแหน่งมือ
DA	Hændernes placering	SQ	Pozicionimi i duarve
ET	Käte asend	BS	Pozicioniranje ruku
LV	Roku pozicionēšana	ME	Pozicioniranje ruku
LT	Rankų padėtis	MK	Положба на раце
RU	Позиционирование рук	HY	Ձեռքերի դիրքավորում
UK	Положення рук	VI	Định vị trí bàn tay

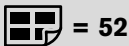

= 52

EN	Smart hill assist	EL	Έξυπνη υποβοήθηση στην ανηφόρα	LV	Viedā virzības kalnā palīdzības sistēma	BS	Pametna asistencija na brdu
DE	Smarte Unterstützung bei hügeligem Gelände	RO	Asistentă inteligentă la deal	LT	Išmanioji pagalba įkalnėje	ME	Pametna asistencija na brdu
ES	Asistencia inteligente para cuestras	IS	Brekkuaðstoð	RU	Смарт-функция для подъема на возвышенности	MK	Помош за блага нагорнина
FR	Assistance intelligente dans les pentes	MT	Assistenza intelligenti għat-tlajja'	UK	Розумна система підтримки на схилах	HY	Սմարթ աջակցութիւն բարձրանալիս
PT	Assistência aos declives inteligente	AR	مساعد الإحاطة الذكي	TR	Akıllı yokuş yardımcısı	VI	Bộ phận hỗ trợ lên xuống dốc thông minh
IT	Assistenza per le salite	FA	کمک هوشمند در سربالایی				
NL	Intelligente ondersteuning op heuvelachtig terrein	YUE	智慧坡道輔助系統				
PL	Inteligentny system wspomagania jazdy	CMN	智能坡道輔助系統				
CS	Chytrý asistent pro jízdu do kopce	JA	スマート坂道アシスト				
SK	Chytrý asistent pre jazdu do kopca	KO	스마트 언덕 보조				
SL	Pametni pomočnik za klance	BG	Интелигентна помощ при наклон				
HR	Pametna asistencija na brdu	SR	Pametna asistencija na brdu				
HU	Okos visszafutásgátló	MS	Pembantu bukit pintar				
SE	Smart assistans för uppförsbackar	HI	स्मार्ट हिल असिस्ट				
NO	Smart bakkeassistent	TH	ระบบช่วยลงเนินอัจฉริยะ				
FI	Älykäs mäkiavustaja	SQ	Asistent inteligjent për malore				
DA	Smart hjælp i bakket terræn	ET	Nutikas mägise maastiku abi				

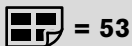

= 53

EN	Uneven surface assist	EL	Υποβοήθηση για ανώμαλες επιφάνειες	DA	Smart hjælp på ujævne overflader	TH	ระบบช่วยบนพื้นผิวที่ไม่สม่ำเสมอ
DE	Smarte Unterstützung bei unebenen Oberflächen	RO	Asistență de suprafață neuniformă	ET	Ebaühtlase pinna läbimisabi	SQ	Asistent për sipërfaqe jo të sheshta
ES	Asistencia para superficies irregulares	IS	Aðstoð á ójöfnu undirlagi	LV	Virzības pa nelīdzenu virsmu palīdzības sistēma	BS	Asistencija na neravnim površinama
FR	Assistance sur les surfaces inégales	MT	Assistenza għal fuq uçuħ mhux lixxi	LT	Pagalba važiuojant ant nelygių dangos	ME	Asistencija na neravnim površinama
PT	Assistência às superficies irregulares	AR	خاصية دعم الحركة على الأسطح غير المستوية	RU	Смарт-функция для работы на неровных поверхностях	MK	Помош за нерамна површина
IT	Assistenza per superfici non uniformi	FA	کمک جهت سطوح ناصاف	UK	Система підтримки на нерівній поверхні	HY	Անհարթ մակերեսի արջակցություն
NL	Ondersteuning voor oneffen oppervlaktes	YUE	凹凸不平表面輔助系統	TR	Düzgün olmayan yüzey yardımcısı	VI	Bộ phận hỗ trợ khi đi trên bề mặt không bằng phẳng
PL	Wspomaganie jazdy po nierównym terenie	CMN	凹凸不平表面輔助系統				
CS	Asistent jízdy na nerovném povrchu	JA	でこぼこ道アシスト				
SK	Asistent jazdy na nerovnom povrchu	KO	평탄하지 않은 표면 보조				
SL	Pametni pomočnik za neravne površine	BG	Помощ при неравни повърхности				
HR	Asistencija na neravnim površinama	SR	Asistencija na neravnim površinama				
HU	Egyenetlenfelület-asszisztens	MS	Pembantu permukaan tidak rata				
SE	Assistans vid ojämn underlag	HI	असमान सतह सहायता				
NO	Ujevn overflate-assistent	FI	Älykäs avustaja epätasaisilla pinnoilla				



 = 54

EN	Folding	TR	Katlama
DE	Faltung	EL	Αναδίπλωση
ES	Plegado	RO	Pliere
FR	Pliant	IS	Brjóta saman
PT	Fecho	MT	Tiwi
IT	Ripiegamento	AR	
NL	Vouwen	FA	
PL	Składanie	YUE	折疊
CS	Skládání	CMN	折疊
SK	Zloženie	JA	折りたたみ
SL	Zlaganje	KO	접기
HR	Preklapanje	BG	Сгъване
HU	Összecsukás	SR	Preklapanje
SE	Ihopfällning	MS	Lipat
NO	Sammenlegging	HI	फोल्डिंग
FI	Kokoon taittaminen	TH	การพับ
DA	Sammenklapning	SQ	Palosja
ET	Kokkuvoltimine	BS	Preklapanje
LV	Salocīšana	ME	Preklapanje
LT	Lankstymas	MK	Склопување
RU	Складывание	HY	Ծախելը
UK	Складання	VI	Gập lại

قابلية للطي
تا كردن



 = 56

EN	Two wheel mode	TR	iki tekerlekli mod
DE	Zweirad-Modus	EL	Λειτουργία δύο τροχών
ES	Modo de dos ruedas	RO	Mod cu două roți
FR	Mode deux roues	IS	Stilling fyrir tvö hjól
PT	Modo de duas rodas	MT	Modalità b'żewġ roti
IT	Modalità a due ruote	AR	وضع العجلتين
NL	Tweewiel-modus	FA	حالت دوچرخ
PL	Typ dwukołowy	YUE	兩輪模式
CS	Režim dvou kol	CMN	两轮模式
SK	Dvojkolesový režim	JA	2輪モード
SL	Dvokolesni način	KO	두 휠 모드
HR	Režim rada s dva kotača	BG	Режим с две колела
HU	Kétkerék mód	SR	Režim rada na dva točka
SE	Tvåhjulsläge	MS	Mod dua roda
NO	Tohjulmodus	HI	दो पहिया मोड
FI	Kaksipyöräinen tila	TH	โหมดสองล้อ
DA	Tohjulstilstand	SQ	Modaliteti me dy rrota
ET	Kahe ratta režiim	BS	Režim rada na dva točka
LV	Divu riteņu režīms	ME	Režim rada na dva točka
LT	Dviejų ratų režimas	MK	Режим за две тркала
RU	Двухколесный режим	HY	Երկսկիւղի ռեժիմ
UK	Двоколісний режим	VI	Chế độ hai bánh xe



= 57

EN	Brake	TR	Fren
DE	Bremse	EL	Φρένα
ES	Freno	RO	Frână
FR	Frein	IS	Bremsa
PT	Bloqueio	MT	Brejġ
IT	Freno	AR	
NL	Rem	FA	
PL	Hamulec	YUE	剎車
CS	Brzda	CMN	刹车
SK	Brzda	JA	ブレーキ
SL	Zavora	KO	브레이크
HR	Kočnica	BG	Спирачка
HU	Fék	SR	Коћница
SE	Broms	MS	Brek
NO	Brems	HI	ब्रेक
FI	Jarru	TH	เบรค
DA	Bremse	SQ	Frenat
ET	Pidur	BS	Коћница
LV	Bremze	ME	Коћница
LT	Stabdys	MK	Сопирачка
RU	Тормоза	HY	Արգելակ
UK	Гальма	VI	Phanh thắng

المكابح
ترمز



= 58

EN	Handle bar	TR	Tutma sapı
DE	Schiebegriff	EL	Ράβρος λαβής
ES	Manillar	RO	Mâner
FR	Poignée de poussée	IS	Handfang
PT	Guiador	MT	Handle bar
IT	Manubrio	AR	عارضضة المقبض
NL	Duwstang	FA	میله دسته
PL	Uchwyt	YUE	把手
CS	Madlo	CMN	把手
SK	Rukoväť	JA	ハンドルバー
SL	Ročaj	KO	핸들 바
HR	Ručice	BG	Кормило
HU	Tolókar	SR	Ručke
SE	Handtag	MS	Bar pemegang
NO	Håndtak	HI	हैंडल बार
FI	Työntökahva	TH	ด้ามจับ
DA	Styr	SQ	Shufra e dorezës
ET	Sang	BS	Ručice
LV	Rokturis	ME	Ručke
LT	Rankena	MK	Рачка
RU	Рукоятка	HY	Վարալվարման բռնակ
UK	Рукоятка	VI	Tay cầm



 = 58

EN Seat direction	TR Koltuk yönü
DE Sitzrichtung	EL Κατεύθυνση καθίσματος
ES Dirección de la silla	RO Direcție scaun
FR Sens du siège	IS Sætisstefna
PT Orientação do assento	MT Direzzjoni tas-sit
IT Direzione di seduta	AR اتجاه المقعد
NL Zitrichting	FA جهت صندلی
PL Kierunek siedzenia	YUE 座椅方向
CS Směr sedadla	CMN 座椅方向
SK Smer sedadla	JA シートの方向
SL Smer sedeža	KO 좌석 방향
HR Smjer sjedala	BG Посока на седалката
HU Ülésirány	SR Smer sedišta
SE Sitsriktning	MS Arah kerusi
NO Seteretning	HI सीट दिशा
FI Istumasuunta	TH ทิศทางที่นั่ง
DA Sæderetning	SQ Drejtimi i ndenjësës
ET Istme suund	BS Smjer sjedišta
LV Sēdekļa virziens	ME Smjer sjedišta
LT Kėdutės kryptis	MK Правец на седиште
RU Направление сиденья	HY Նստատեղի ուղղություն
UK Напрямок сидіння	VI Hướng ghế ngồi



 = 59

EN Backrest	TR Arkalık
DE Rückenlehne	EL Πλάτη
ES Respaldo	RO Spătar
FR Dossier	IS Bak
PT Encosto de costas	MT Serf id-dahar
IT Schienale	AR مسند الظهر
NL Rugleuning	FA پشتی
PL Oparcie	YUE 靠背
CS Opěradlo	CMN 靠背
SK Operadlo	JA 背もたれ
SL Naslonjalo	KO 등받이
HR Naslon	BG Облегалка
HU Háttámla	SR Naslon
SE Ryggstöd	MS Penyangdar belakang
NO Rygglene	HI बैकरेस्ट
FI Selkänoja	TH พนักพิง
DA Ryglæn	SQ Mbështetësja e shpinës
ET Seljatugi	BS Naslon
LV Atzveltne	ME Naslon
LT Nugaros atlošas	MK Наслон за грб
RU Спинка	HY Թիվսակ
UK Спинка	VI Phấn tựa lưng



 = 59

EN	Legrest	TR	Bacac desteği
DE	Beinstütze	EL	Στήριγμα ποδιών
ES	Reposapiés	RO	Suport picior
FR	Repose-pieds	IS	Fótahvíla
PT	Apoio de pernas	MT	Serh is-saqajn
IT	Poggiagambe	AR	
NL	Beensteun	FA	میمند المساق جاپایی
PL	Podnózek	YUE	腿托
CS	Opěrka nohou	CMN	腿托
SK	Opierka nôh	JA	足のせ
SL	Naslon za noge	KO	다리받이
HR	Naslon za noge	BG	Подложка за крака
HU	Lábtartó	SR	Naslon za noge
SE	Benstöd	MS	Tempat letak kaki
NO	Benstøtte	HI	लेगरेस्ट
FI	Jalkatuki	TH	ที่วางขา
DA	Benstøtte	SQ	Mbështetësja e këmbëve
ET	Jalatugi	BS	Naslon za noge
LV	Kāju balsts	ME	Naslon za noge
LT	Kojų atrama	MK	Наслон за носе
RU	Подставка для ног	HY	Ուղեքրի հեղման կտն
UK	Опора для ніг	VI	Phàn tựa chân



 = 60

EN	Bumper bar	TR	Tampon çubuğu
DE	Schutzbügel	EL	Μπάρα διάταξης προστασίας
ES	Barra de seguridad	RO	Bară de protecție
FR	Barre de protection	IS	Þverbiti
PT	Barra de segurança	MT	Strixxa tal-bumper
IT	Barra paraurti	AR	عازضة ممتص الصدمات
NL	Veiligheidsbeugel	FA	میله ضربهگیر
PL	Pałak zabezpieczający	YUE	保險杠
CS	Dětské madlo	CMN	保險杠
SK	Detská rúčka	JA	バンパーバー
SL	Varnostni lok	KO	범퍼 바
HR	Štitnik	BG	Броня
HU	Karfa	SR	Štitnik
SE	Stötfångare	MS	Bar bumper
NO	Fender	HI	बम्पर बार
FI	Suojakaari	TH	แบรินชน
DA	Sikkerhedsbøjle	SQ	Shufra e parakolpiti
ET	Turvakaar	BS	Štitnik
LV	Aizsarglōks	ME	Štitnik
LT	Amortizatoriaus strypas	MK	Одбојник
RU	Поручень	HY	Թափարգել
UK	Обмежувальний поручень	VI	Thanh chống va đập



EN	Harness
DE	Gurtsystem
ES	Arnés
FR	Harnais
PT	Arnês
IT	Imbracatura
NL	Harnas
PL	Szelki
CS	Popruh
SK	Popruh
SL	Varnostni pas
HR	Sustav vezivanja
HU	Biztonsági öv
SE	Sele
NO	Beltsystem
FI	Vyöjärjestelmä
DA	Selesystem
ET	Turvarihmad
LV	Drošības josta
LT	Diržai
RU	Ремни безопасности
UK	Ремінь

TR	Emniyet kemeri
EL	Συγκράτηση
RO	Centură
IS	Beisli
MT	Ċinga tas-sigurtà
AR	طقم الشد
FA	سیستم مهار
YUE	安全帶
CMN	安全带
JA	安全ベルト
KO	하네스
BG	Сбруя
SR	Sistem vezivanja
MS	Abah-abah
HI	कवच
TH	ระบบสายรัด
SQ	Pajimet
BS	Sistem vezivanja
ME	Sistem vezivanja
MK	Сигурносен каиш
HY	Անրազոսի
VI	Dây an toàn



EN	Sun canopy
DE	Sonnenverdeck
ES	Capota para el sol
FR	Pare-soleil
PT	Capota solar
IT	Parasole
NL	Zonnekap
PL	Oslona przeciwsłoneczna
CS	Stříška proti slunci
SK	Strieška proti slnku
SL	Senčnik za zaščito pred soncem
HR	Tenda za sunce
HU	Kupola
SE	Solsufflett
NO	Solskjerm
FI	Aurinkokatos
DA	Solkaleche
ET	Päikesevari
LV	Saules aizsegs
LT	Stogelis nuo saulės
RU	Солнцезащитный козырек
UK	Тент від сонця

TR	Güneş başlığı
EL	Κουκούλα για τον ήλιο
RO	Copertină
IS	Sólartjald
MT	Kopertura mix-xemx
AR	مظلة الشمس
FA	سایبان
YUE	遮陽蓬
CMN	遮阳蓬
JA	日よけ力バー
KO	선 캐노피
BG	Тента
SR	Tenda za sunce
MS	Kanopi matahari
HI	धूप छतरी
TH	หลังคาบังแดด
SQ	Strea për diellin
BS	Tenda za sunce
ME	Tenda za sunce
MK	Стреа за сонце
HY	Արևապաշտպան ծածկ
VI	Mái che nắng



 = 64

EN	Swivel locks	TR	Tekerlek kilidi
DE	Schwenkradsperre	EL	Περιστρεφόμενες κλειδαριές
ES	Bloqueos de dirección	RO	Încuietori pivotante
FR	Verrous pivotants	IS	Snúningslásar
PT	Bloqueios de rotação	MT	Lokks li jduru
IT	Blocchi girevoli	AR	أقفال دوران العجلات
NL	Zwenkvergrendeling	FA	قفل‌های دوران نوسان
PL	Blokada obrotu	YUE	旋轉鎖
CS	Aretační zámky	CMN	旋轉鎖
SK	Aretačné zámky	JA	回転ロック
SL	Blokada vrtenja	KO	회전 잠금장치
HR	Zaključavanje okretanja	BG	Завъртащи се ключалки
HU	Beállás-zár	SR	Zakretni mehanizmi
SE	Vridlås	MS	Kunci ayun
NO	Svingelåser	HI	कुंडा ताले
FI	Kääntölukko	TH	ตัวล็อกแบบหมุน
DA	Drejelås	SQ	Kuçja e rrotave
ET	Pöördlukustus	BS	Zakretni mehanizmi
LV	Rotācijas bloķētāji	ME	Zakretni mehanizmi
LT	Šarnyriniai fiksatoriai	MK	Заклучување на тркалата
RU	Блокировки вращения	HY	Պտտվող Կողմիչներ
UK	Замок шарніра	VI	Khóa xoay



 = 65

EN	Removing the wheels	TR	Tekerlekleri çıkarma
DE	Entfernen der Räder	EL	Αφαίρεση των τροχών
ES	Quitar las ruedas	RO	Îndepărtarea roților
FR	Retrait des roues	IS	Fjarlægja hjól
PT	Remover as rodas	MT	Tneħhija tar-roti
IT	Rimozione delle ruote	AR	فك العجلات
NL	De wielen verwijderen	FA	باز کردن چرخ‌ها
PL	Zdejmowanie kółek	YUE	拆卸車輪
CS	Odstranění koleček	CMN	拆卸车轮
SK	Odstránenie koliesok	JA	車輪の取り外し
SL	Odstranjevanje koles	KO	휠 제거
HR	Uklanjanje kotača	BG	Демонтиране на колелата
HU	Kerekék eltávolítása	SR	Uklanjanje točkova
SE	Ta bort hjulen	MS	Menanggalkan roda
NO	Fjerne hjulene	HI	पहियों को हटाना
FI	Pyörien poisto	TH	การถอดล้อ
DA	Fjernelse af hjulene	SQ	Heqja e rrotave
ET	Rataste eemaldamine	BS	Uklanjanje točkova
LV	Riteņu atvienošana	ME	Uklanjanje točkova
LT	Ratų nuėmimas	MK	Отстранување на тркалата
RU	Снятие колес	HY	Անիվները հանելը
UK	Зняття коліс	VI	Tháo bánh xe



 = 66

EN Rain cover
DE Regenverdeck
ES Funda para la lluvia
FR Housse de pluie
PT Capa de chuva
IT Parapioggia
NL Regenhoes
PL Osłona od deszczu
CS Pláštěnka
SK Kryt proti dažďu
SL Dežna prevleka
HR Pokrivač za kišu
HU Esővédő
SE Regnskydd
NO Kalesje
FI Sadesuoja
DA Regnslag
ET Vihmakate
LV Pretlietus pārvalks
LT Uždangalas nuo lietaus
RU Дождевик
UK Дошовик

TR Yağmurluk
EL Καλύπτρα βροχής
RO Prelată de ploaie
IS Regn yfirbreiðsla
MT Għata mix-xita
AR غطاء المطر
FA روکش باران
YUE 防雨罩
CMN 防雨罩
JA 雨よけ
KO 레인커버
BG Дъждобран
SR Pokrivač za kišu
MS Pelindung hujan
HI रैन कवर
TH ผ้าคลุมกันฝน
SQ Mbulesë për shiun
BS Pokrivač za kišu
ME Pokrivač za kišu
MK Прекривка за дожд
HY Անձրևապաշտպան օձով
VI Tấm che mưa



 = 66

EN Infant Car Seat
DE Babyschale
ES Silla infantil para coche
FR Siège auto pour enfant
PT Cadeira auto infantil
IT Seggiolino per auto
NL Autostoeltje
PL Fotelik dla niemowlaka
CS Vajíčko
SK Autosedačka pre dojčatá
SL Avtosedež za dojenčke
HR Autosjedalica za bebe
HU Gyermekek autósülés
SE Bilbarnstol
NO Barnebilsete
FI Lasten istuin
DA Autostol
ET Imiku turvatool
LV Zīdaiņu sēdekļis
LT Automobiline naujagimio kėdutė
RU Детское автокресло
UK Автокрісло для немовлят

TR Bebek Araba Koltuğu
EL Παιδικό κάθισμα αυτοκινήτου
RO Scaunul auto pentru infant
IS Smábarnabílstóll
MT Sit tal-Karozza tat-Tfal
AR مقعد سيارة للرضع
FA صندلی خودرو برای نوزاد
YUE 嬰兒汽車座椅
CMN 嬰兒汽車座椅
JA 幼児用カーシート
KO 유아용 카시트
BG Бебешка седалка за автомобил
SR Auto sedište za bebe
MS Kerusi Keselamatan Bayi
HI शिशु कार सीट
TH คาร์ซีทสำหรับเด็กทารก
SQ Sexholino
BS Auto sjedište za bebe
ME Auto sjedište za bebe
MK Детско седиште за автомобил
HY Ավտոմոբիլային սնտախոն
VI Ghế xe dành cho trẻ sơ sinh

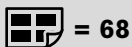

EN	Carry Cot	TR	Portbebe
DE	Kinderwagenaufsatz	EL	Πορτ-μπεμπέ
ES	Capazo	RO	Landou portabil
FR	Navelle bébé	IS	Burðarrúm
PT	Alcofa	MT	Carry Cot
IT	Culla portatile	AR	سرير محمول
NL	Zitbak	FA	ساک حمل نوزاد
PL	Gondola wózka dziecięcego	YUE	便攜嬰兒床
CS	Hluboká korba	CMN	便携嬰兒床
SK	Korba na prenášanie	JA	持ち運びベッド
SL	Nosilna košara	KO	캐리콧
HR	Ležaljka za prenošenje	BG	Легло за носене
HU	Mózeskosár	SR	Dodatak za kolica
SE	Barnvagnslift	MS	Katil Bayi Bimbit
NO	Babybag	HI	कैरी कौट
FI	Kantolaukku	TH	ตะกร้าที่นอนเด็ก
DA	Babylift	SQ	Djep
ET	Vankrikorv	BS	Dodatak za kolica
LV	Bērna gultiņa	ME	Dodatak za kolica
LT	Nešiojamasis lopšys	MK	Кошница за носење
RU	Переносная люлька	HY	Մանկալակի շարժական մահճալակ
UK	Переносне дитяче ліжечко	VI	Nôi xách tay

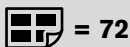

EN	Removing the fabric	TR	Kilifi çıkarma
DE	Entfernen des Bezuges	EL	Αφαίρεση του υφάσματος
ES	Quitar la tela	RO	Îndepărtarea țesăturii
FR	Retrait du tissu	IS	Fjarlægja efni
PT	Remover o tecido	MT	Tnehhija tad-drapp
IT	Rimozione del tessuto	AR	فك القماش
NL	De stof verwijderen	FA	برداشتن پارچه
PL	Zdejmowanie pokrycia	YUE	拆除罩布
CS	Odstranění látky	CMN	拆除罩布
SK	Odstránenie látky	JA	カバーの取り外し
SL	Odstranjevanje blaga	KO	페브릭 제거
HR	Uklanjanje tkanine	BG	Демонтиране на плата
HU	Huzat eltávolítása	SR	Uklanjanje tkanine
SE	Ta bort tyget	MS	Menanggalkan fabrik
NO	Fjerne stoffet	HI	कपड़ा हटाना
FI	Kankaan poisto	TH	การถอดผ้า
DA	Fjernelse af stoffet	SQ	Heqja e copës
ET	Kanga eemaldamine	BS	Uklanjanje tkanine
LV	Pārklājuma atvienošana	ME	Uklanjanje tkanine
LT	Audinio nuėmimas	MK	Отстранување на навлакмата
RU	Снятие ткани	HY	Գործվածքը հանելը
UK	Зняття матерії	VI	Tháo phần vải bọc

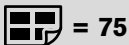

EN	Troubleshooting	TR	Sorun Giderme
DE	Fehlerbehebung	EL	Αντιμετώπιση προβλημάτων
ES	Resolución de problemas	RO	Depanare
FR	Dépannage	IS	Úrræðaleit
PT	Resolução de problemas	MT	Solvien ta' problemi
IT	Risoluzione dei problemi	AR	استكشاف الأخطاء وإصلاحها
NL	Probleemoplossing	FA	عیب‌یابی
PL	Rozwiązywanie problemów	YUE	故障排除
CS	Řešení problémů	CMN	故障排除
SK	Řešenie problémov	JA	トラブルシューティング
SL	Odpravljanje težav	KO	문제 해결
HR	Rješavanje problema	BG	Отстраняване на проблеми
HU	Hibaelhárítás	SR	Rešavanje problema
SE	Felsökning	MS	Menyelesai masalah
NO	Feilsøking	HI	समस्या निवारण
FI	Virheiden poisto	TH	การแก้ไขปัญหา
DA	Problemløsning	SQ	Zgjidhja e problemeve
ET	Tõrkeotsing	BS	Rješavanje problema
LV	Problēmu novēršana	ME	Rješavanje problema
LT	Gedimų šalinimas	MK	Решавање проблеми
RU	Устранение неисправностей	HY	Անսարքու՞թյունների շտկում
UK	Усунення несправностей	VI	Khắc phục sự cố

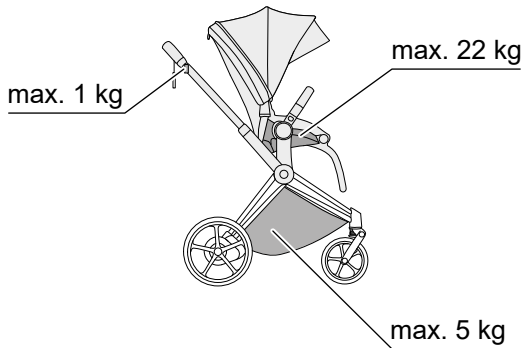

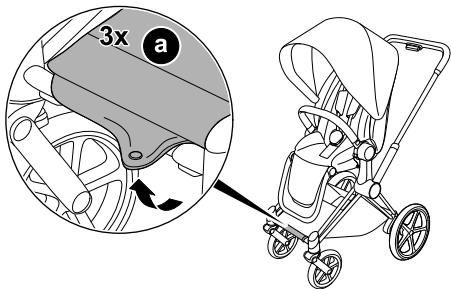

1

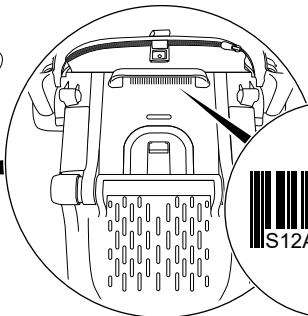
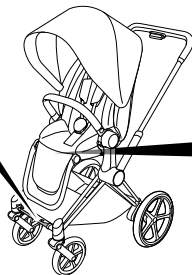
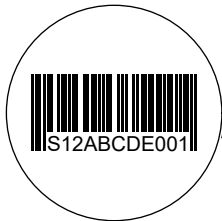

20

2

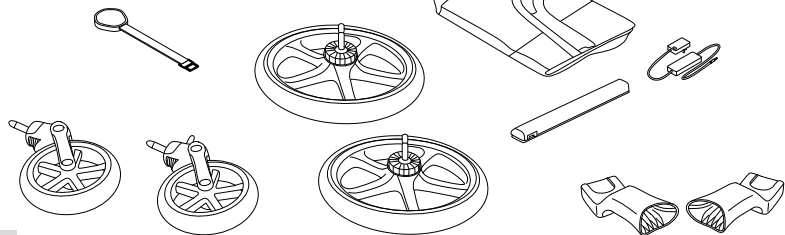
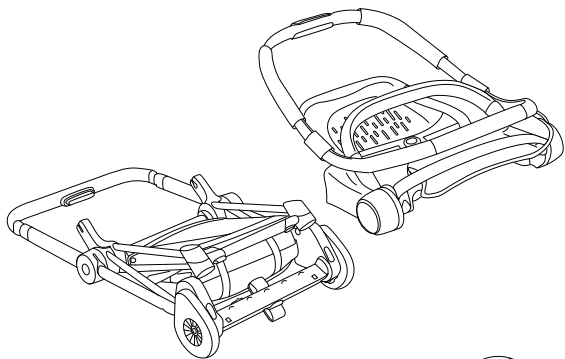

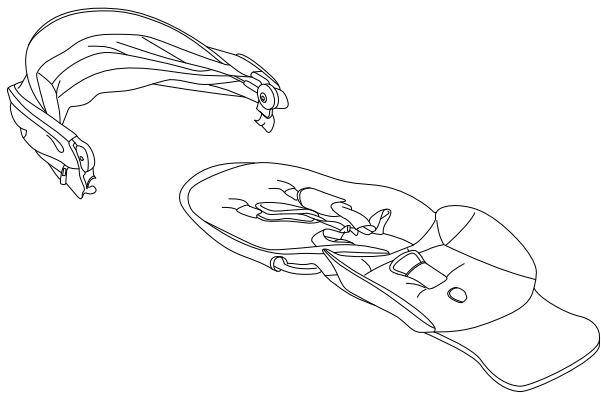

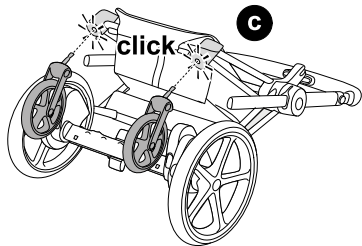
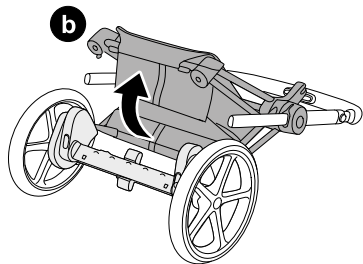
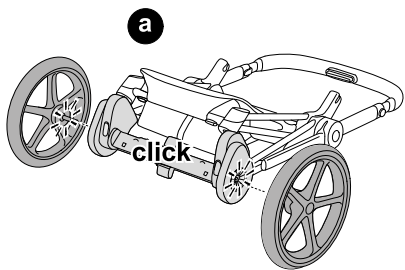

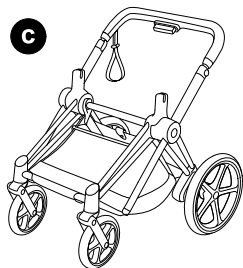
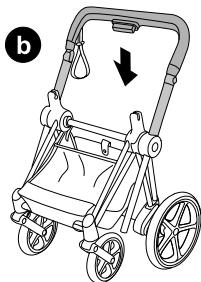
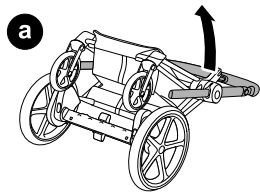

4

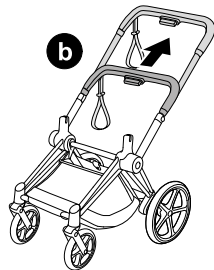
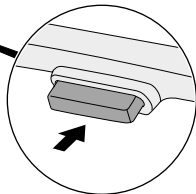
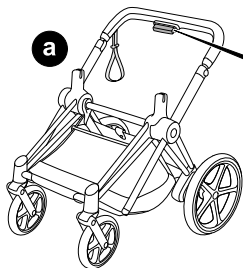

5

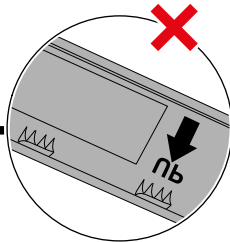
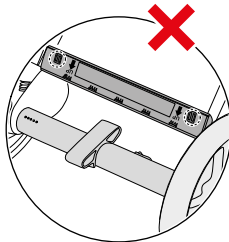
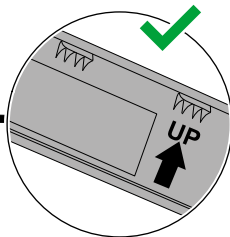
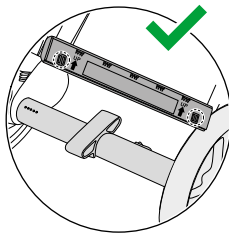
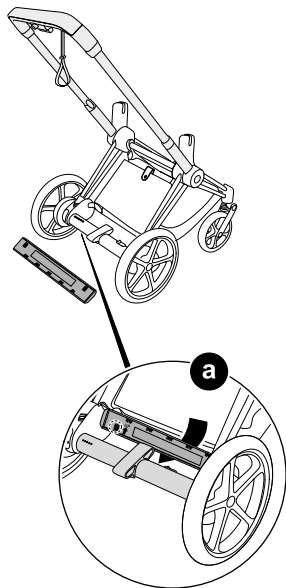

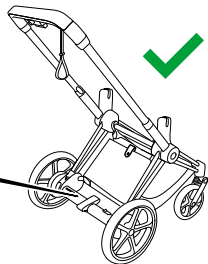
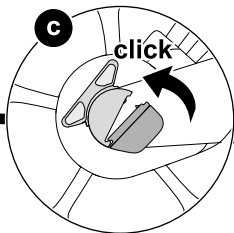
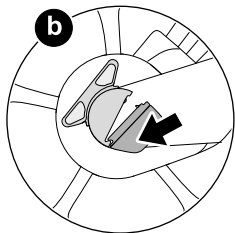

7

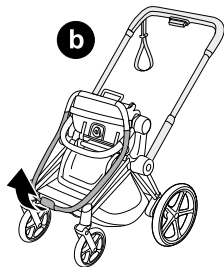
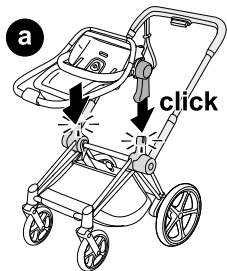

26

8

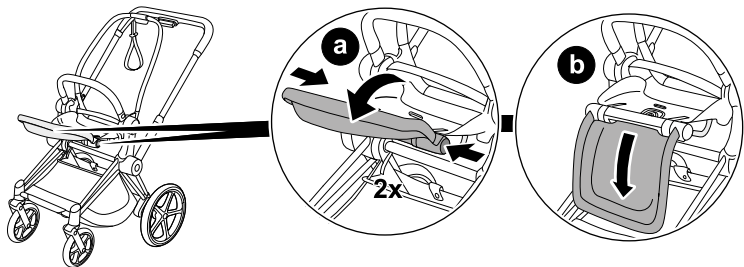

9



10

27

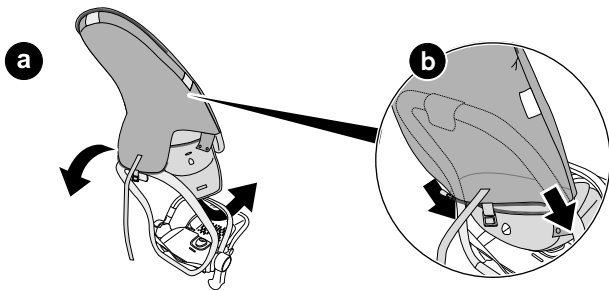

11

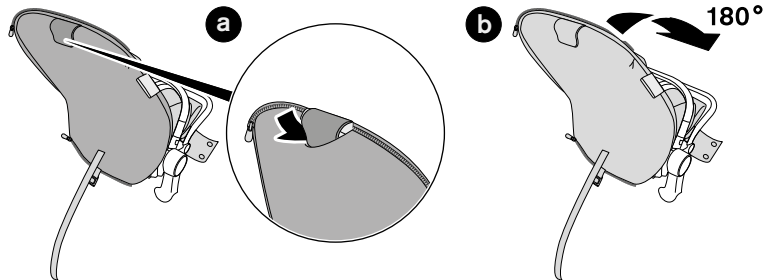

28

12

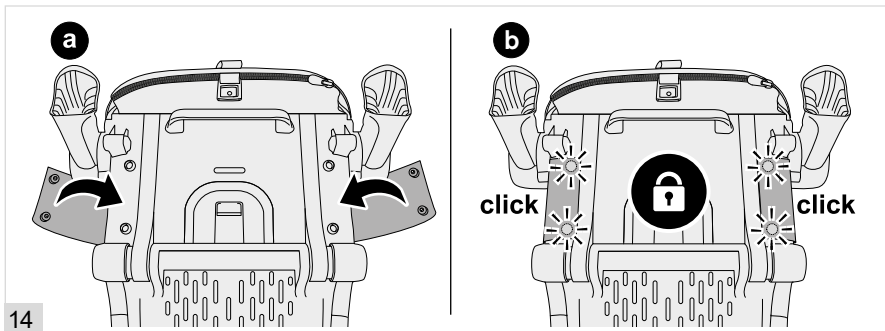
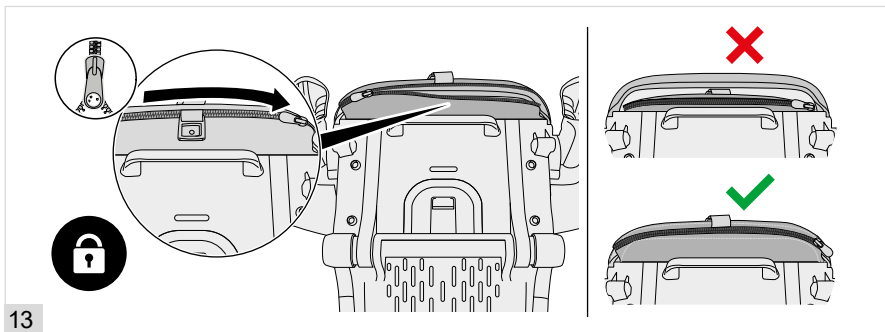

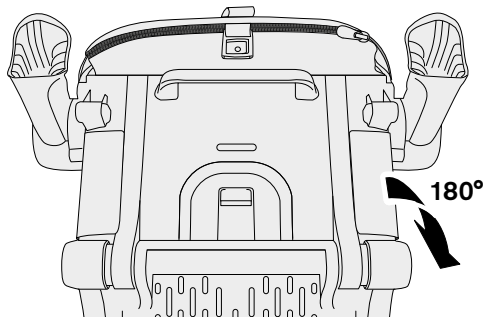

15

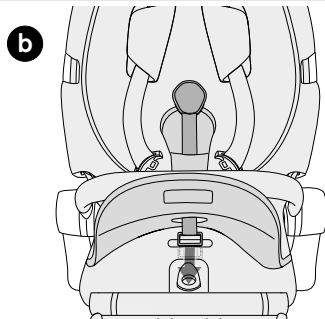
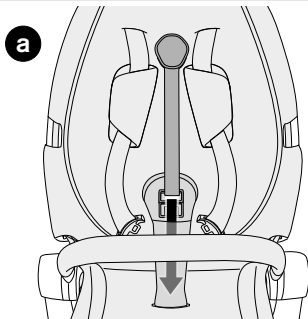

30

16

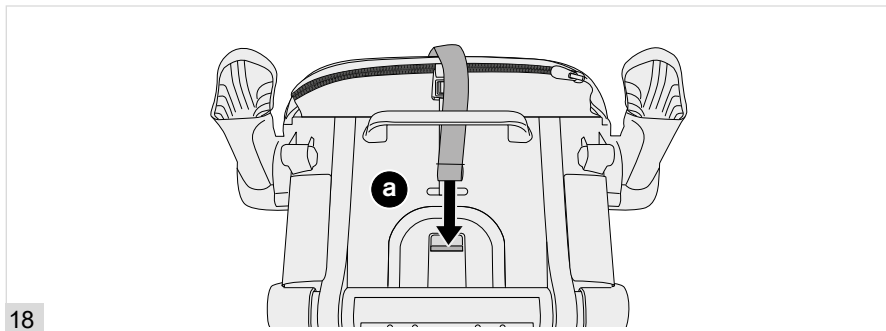
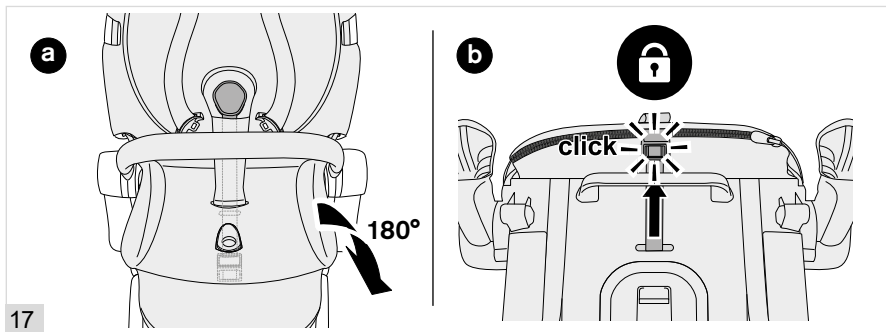

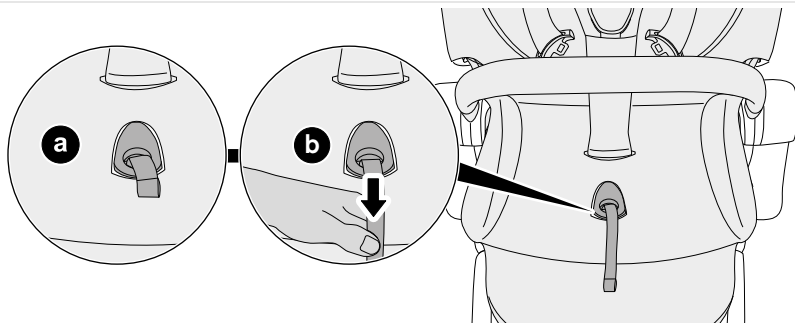
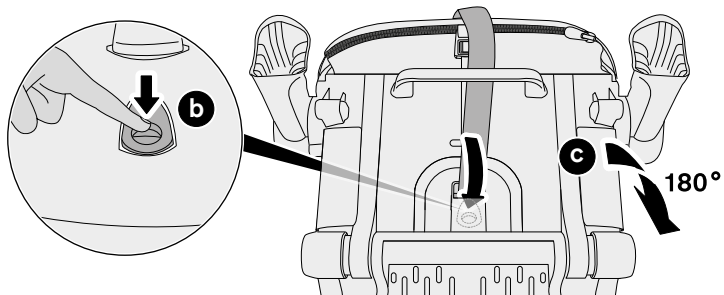

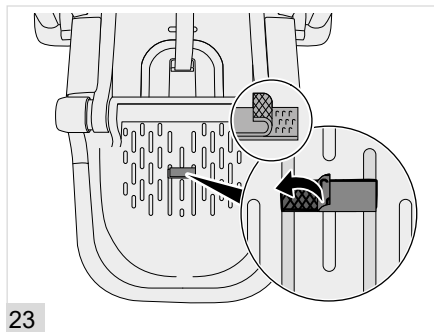
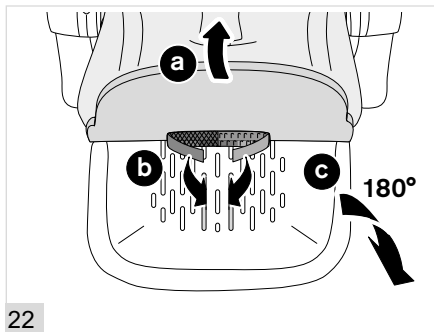
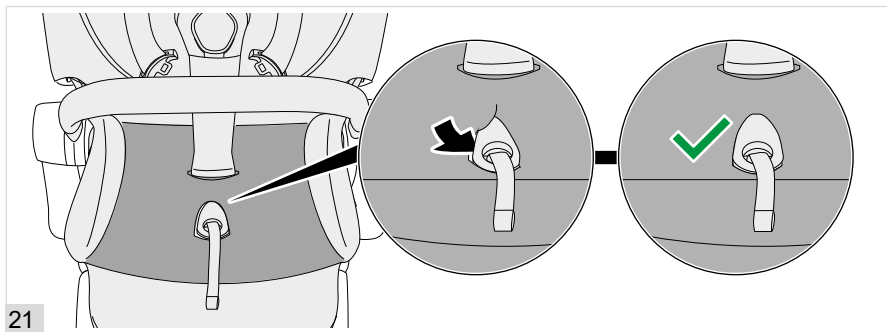

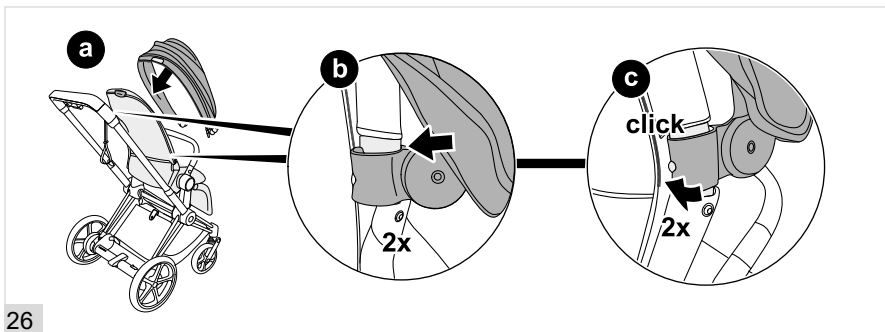
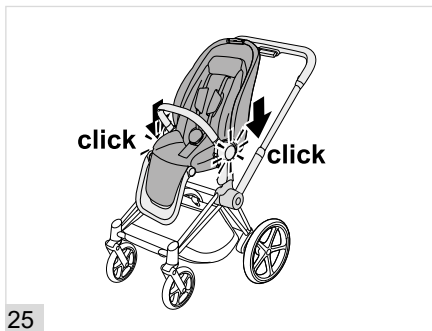
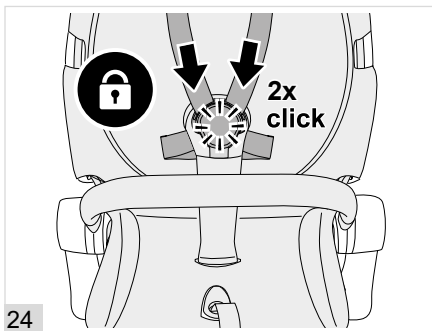

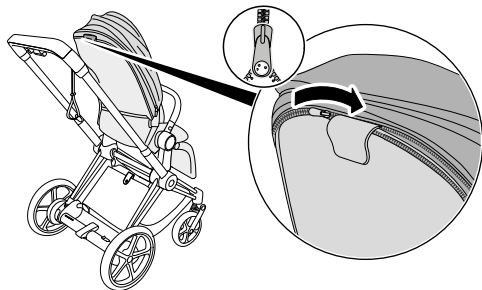

27

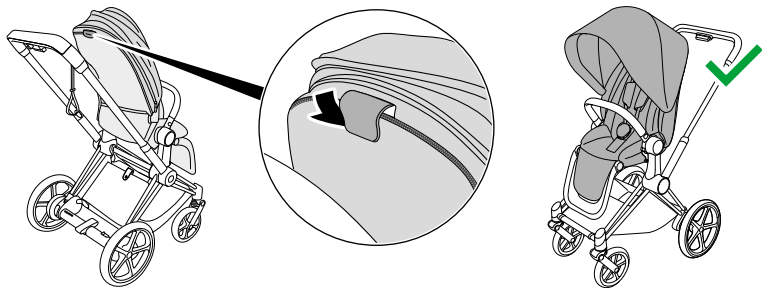

28

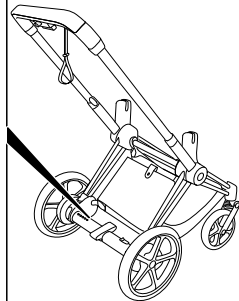
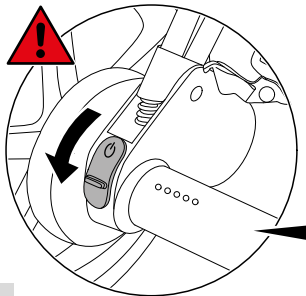

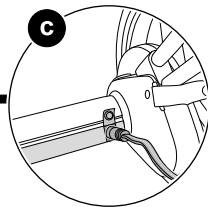
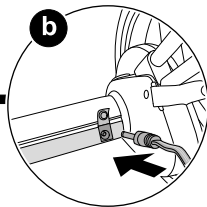
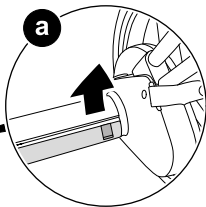
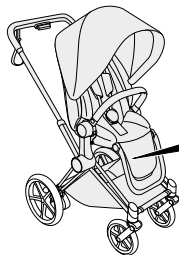

2



100 - 240 V
50/60Hz 1,3A

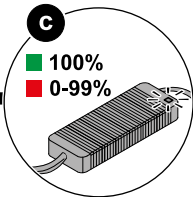
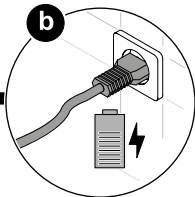
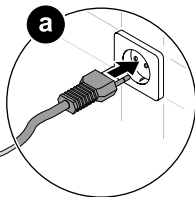

3

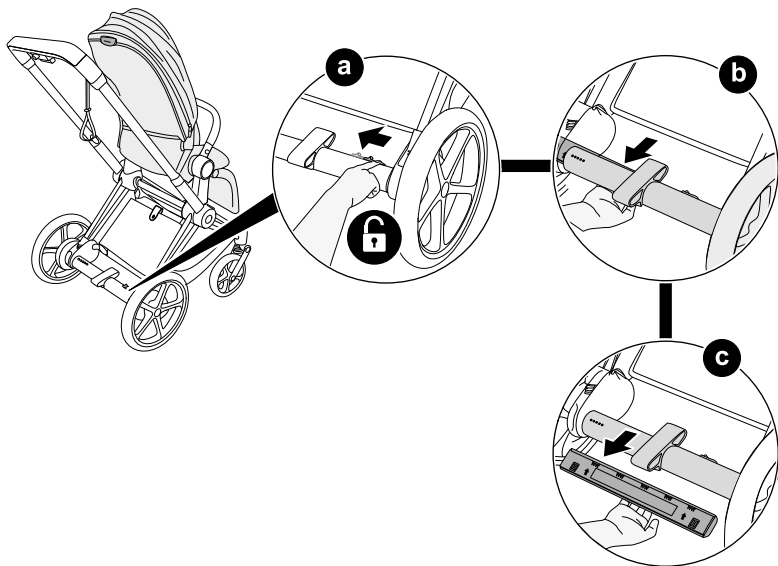

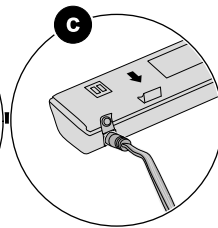
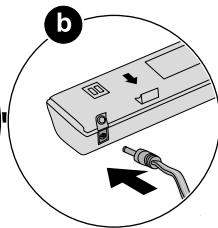
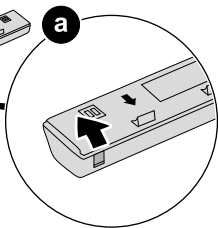
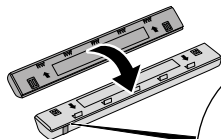

5

100 - 240 V
50/60Hz 1,3A

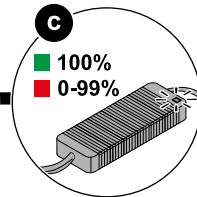
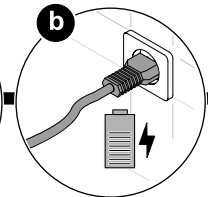
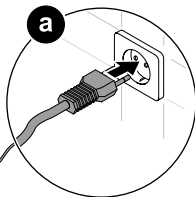
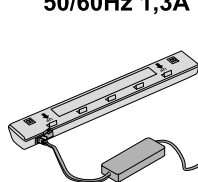

6

39

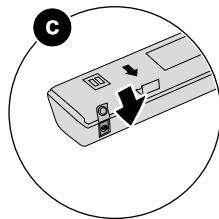
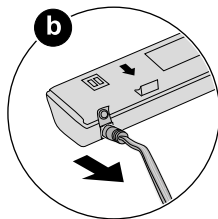
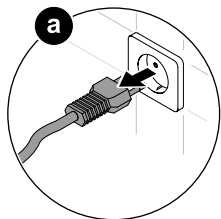

7

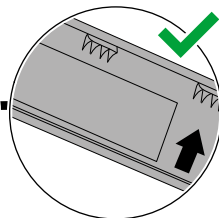
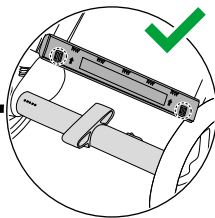
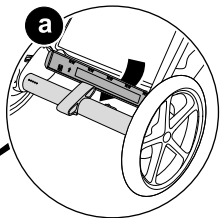
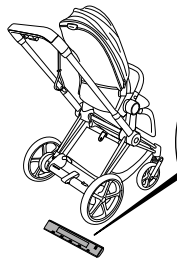

40

8

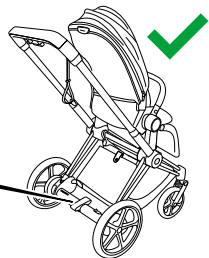
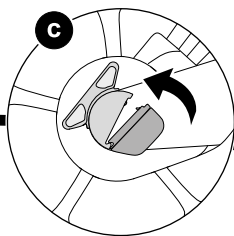
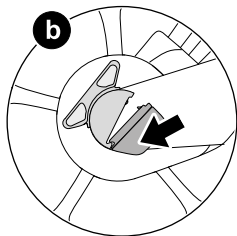

9

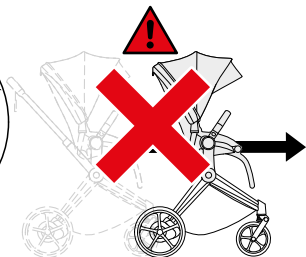
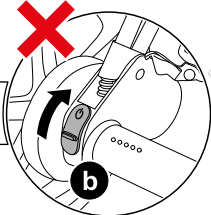
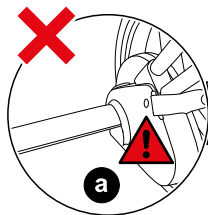
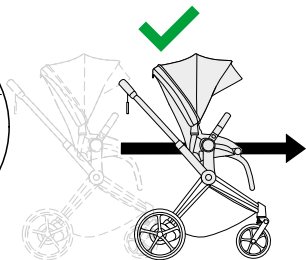
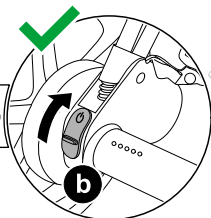
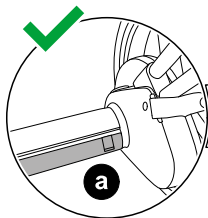

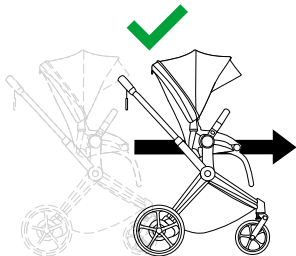
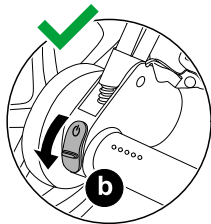
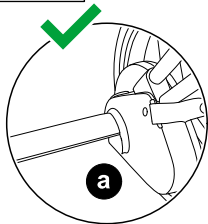

11

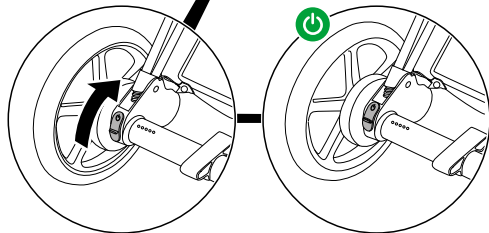
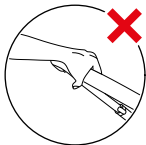
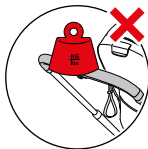
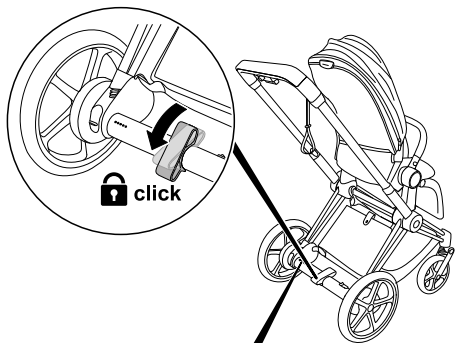

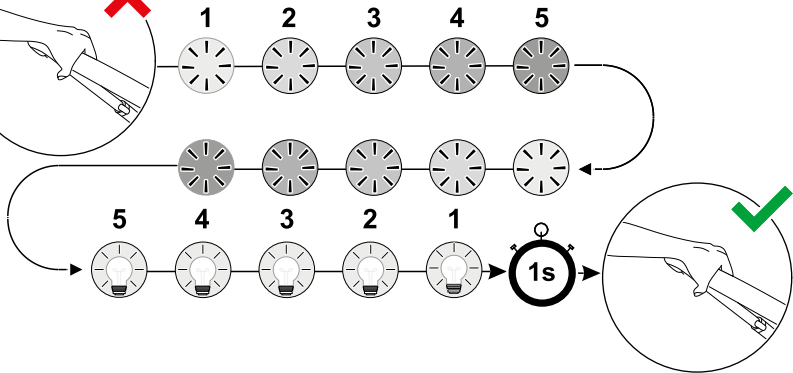
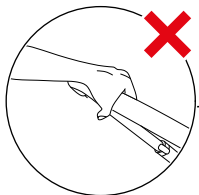
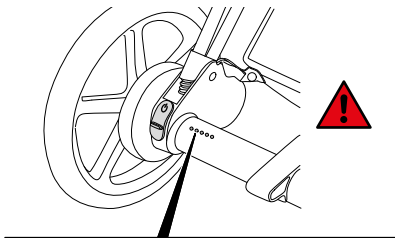
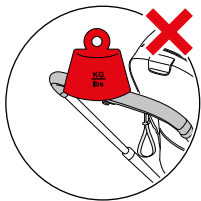

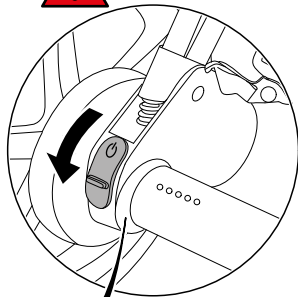
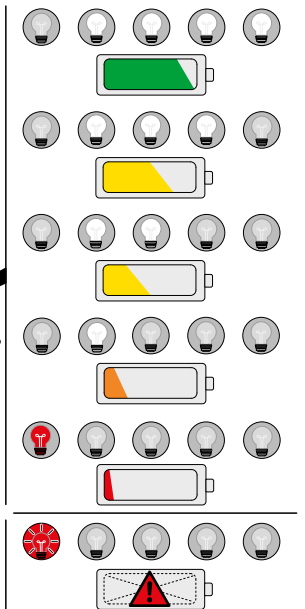
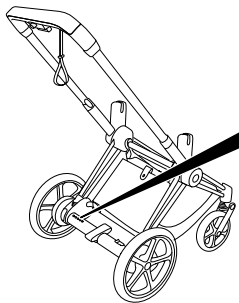

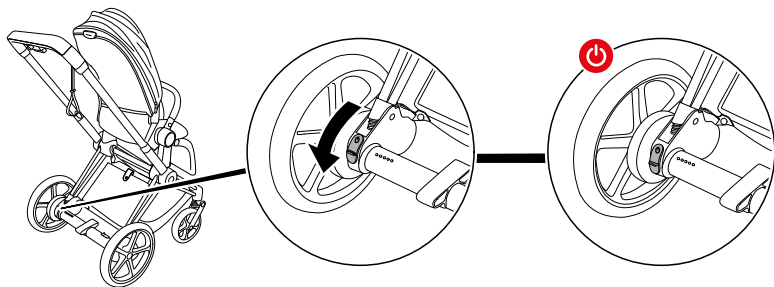

4



1

a



b

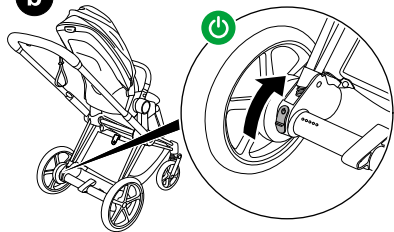

2

c

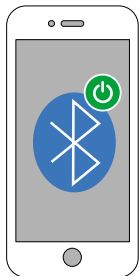

3



d

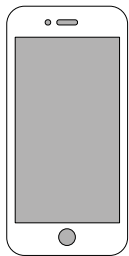

max. 1 m ↔



4

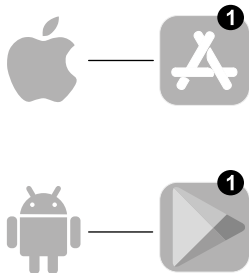

5

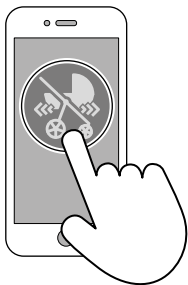

1

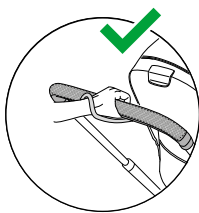
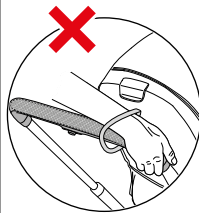
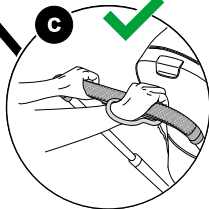
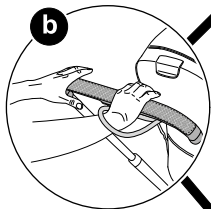
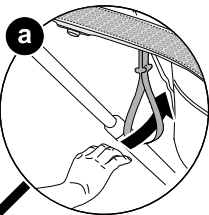
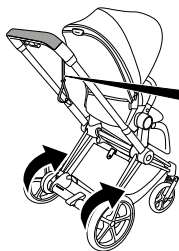



1

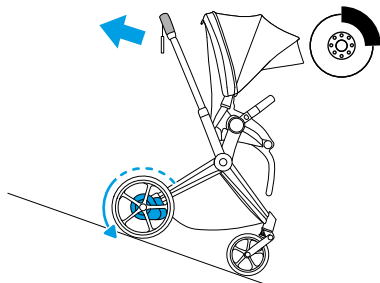
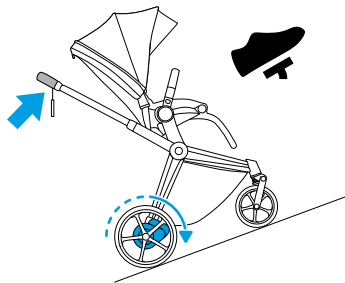

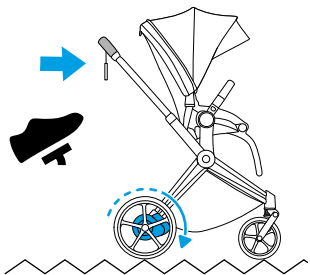

1





a

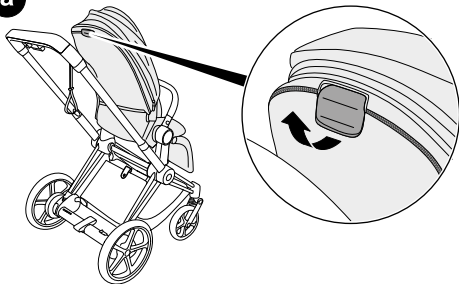

b

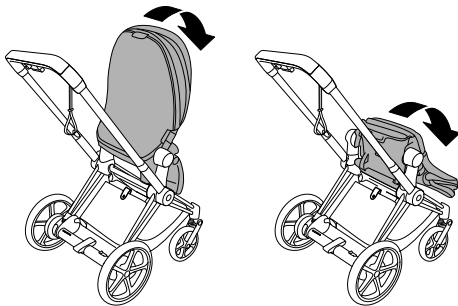

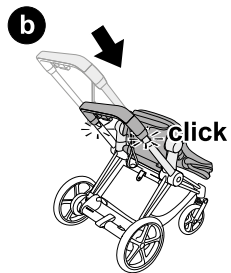
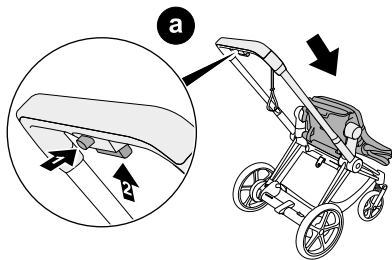

2

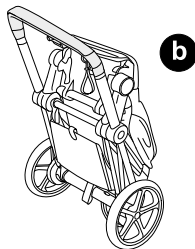
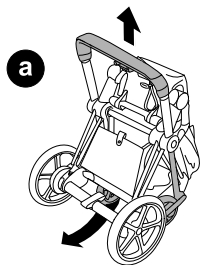

3



1

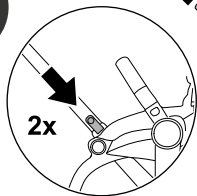
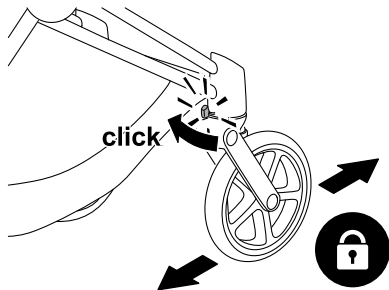

2x

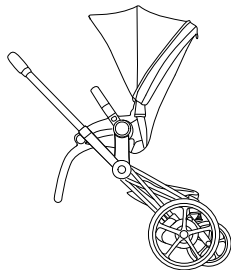
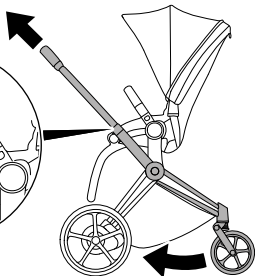

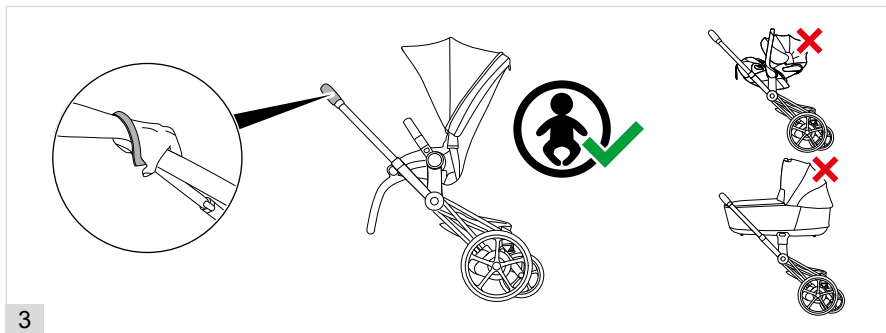

3

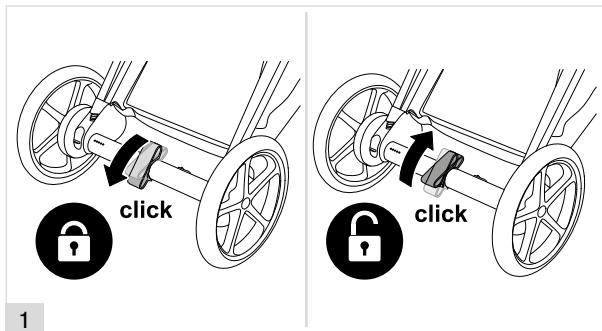

1





a

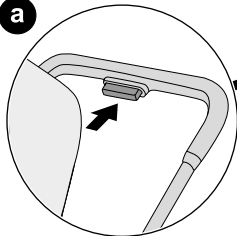

click

b

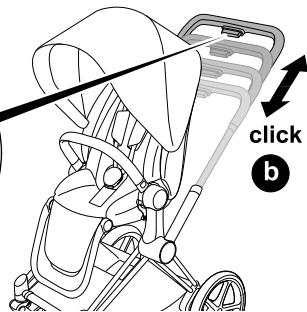

1



a

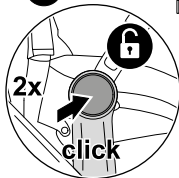

b

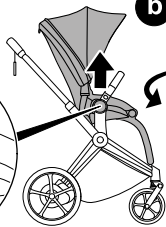

c

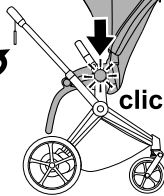

1

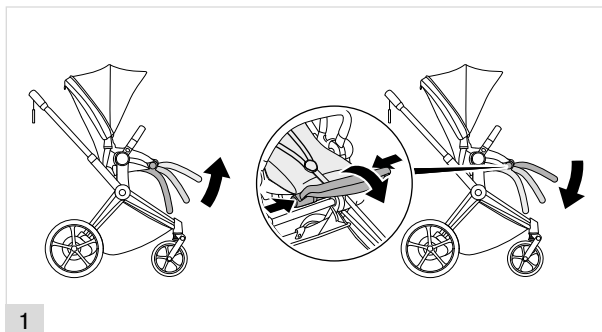
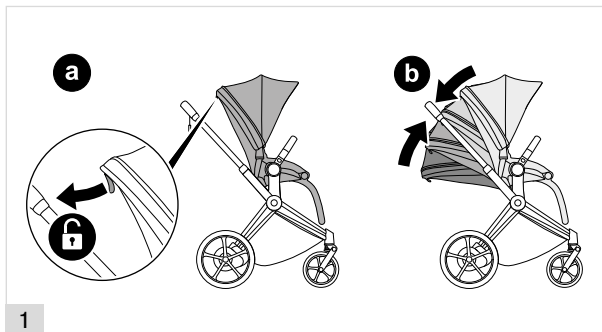

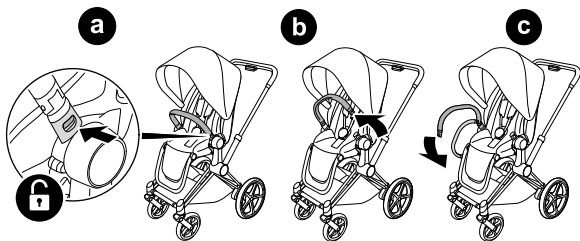

1

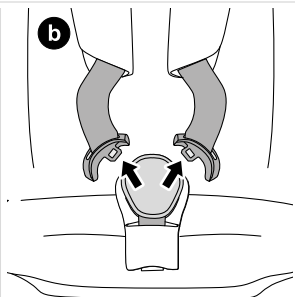
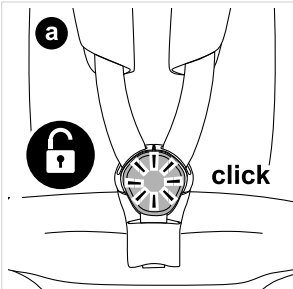

1

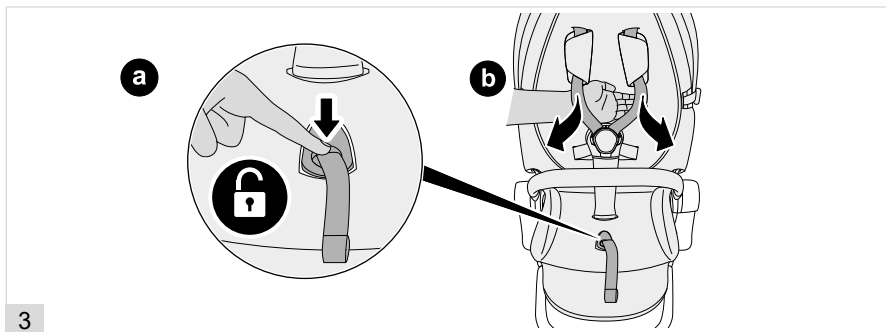
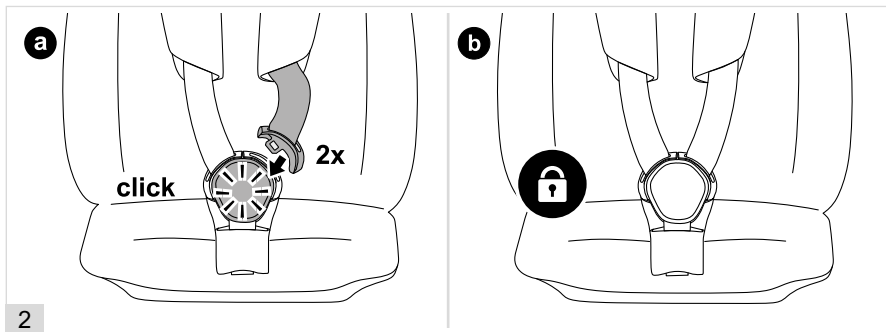

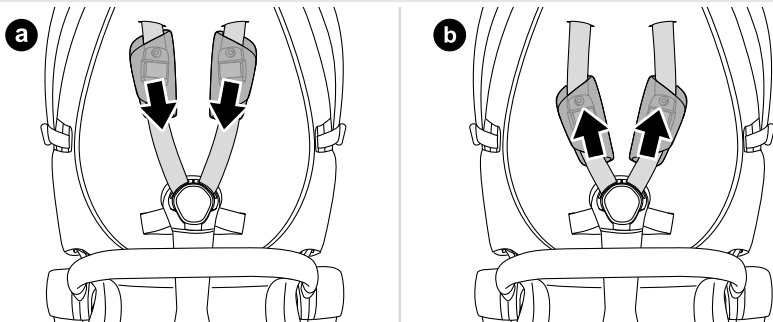
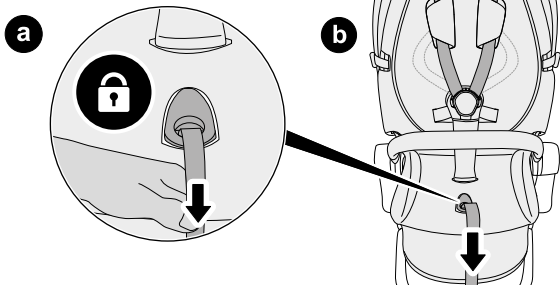

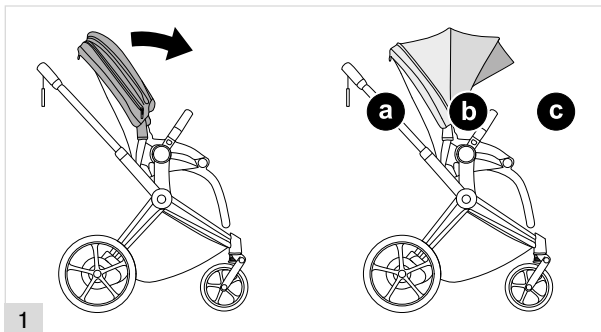
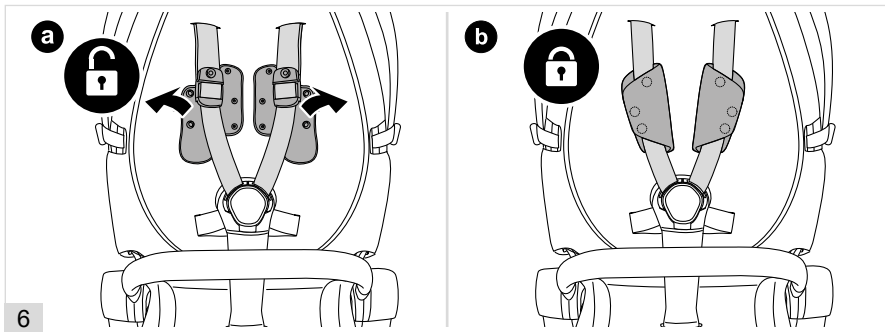

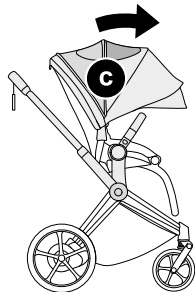
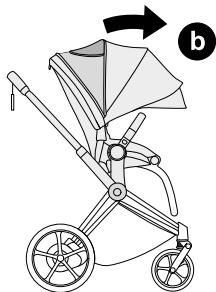
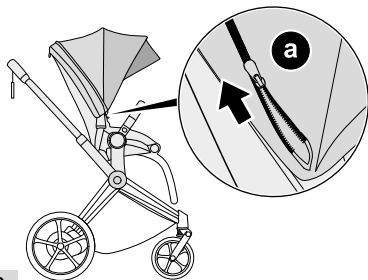

2

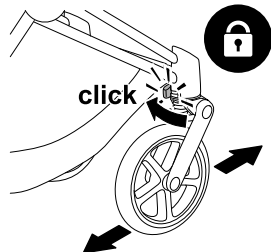
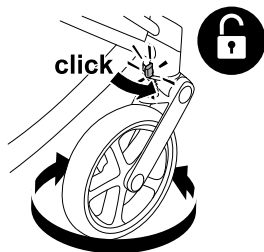

1

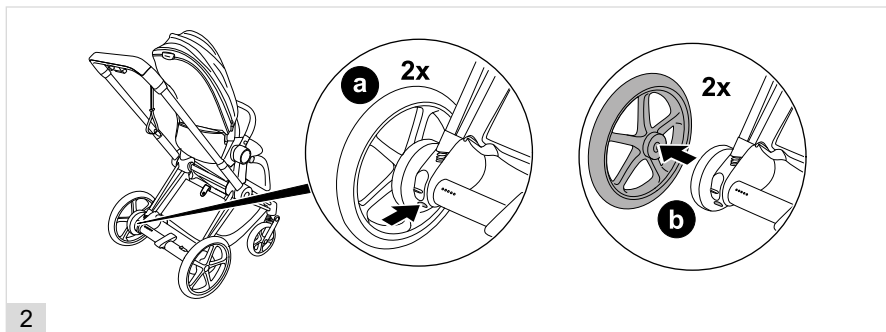
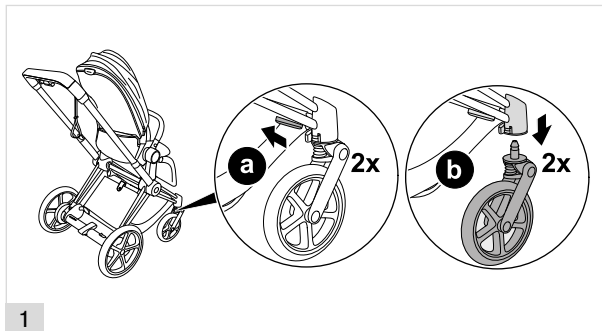

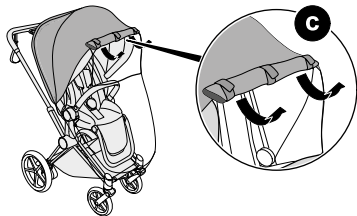

1

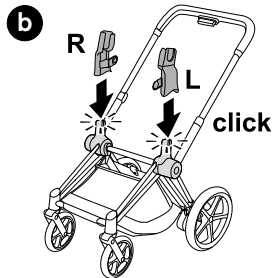
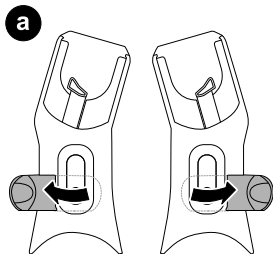

1

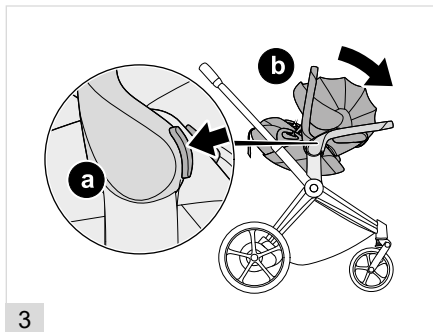

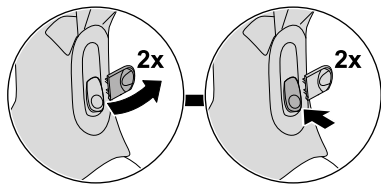

a

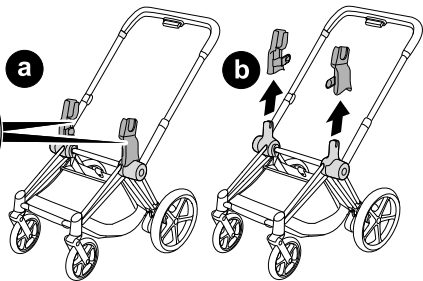

b

5



68

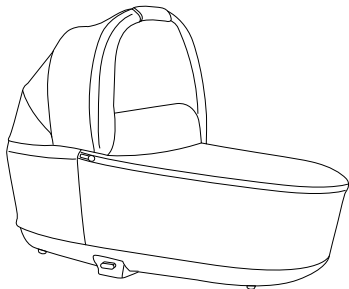

1



a

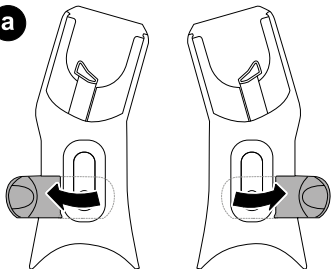

2

b

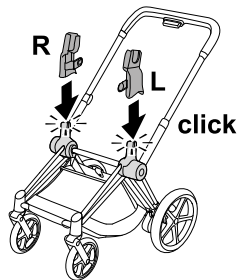

3

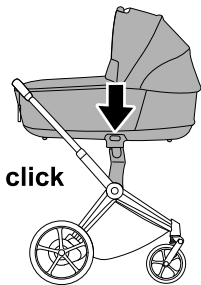

click

4



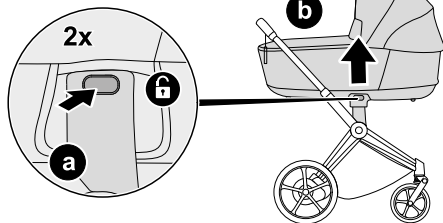

5

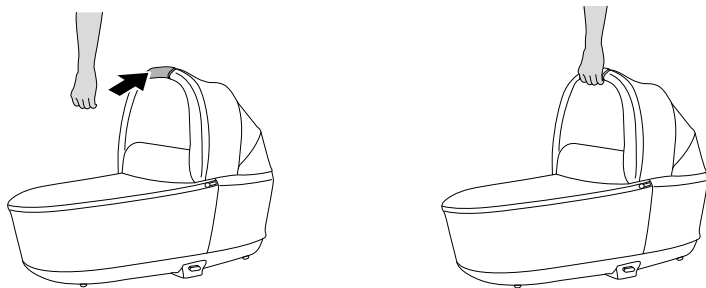

6

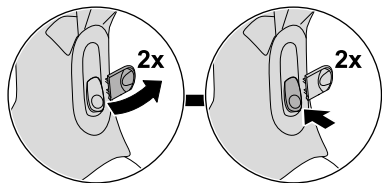

a

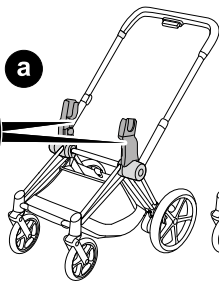

b

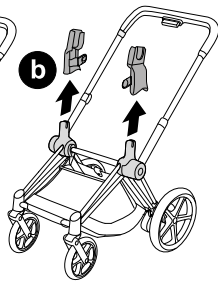

7

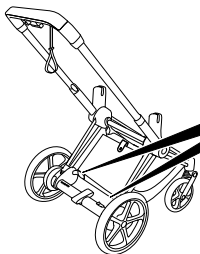
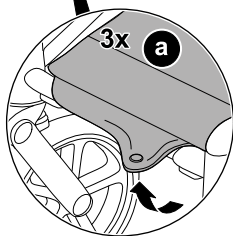
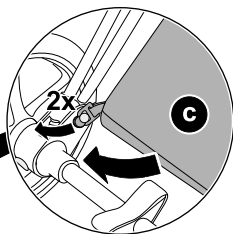
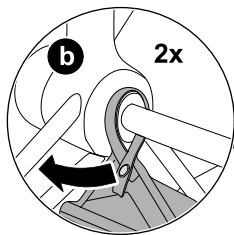

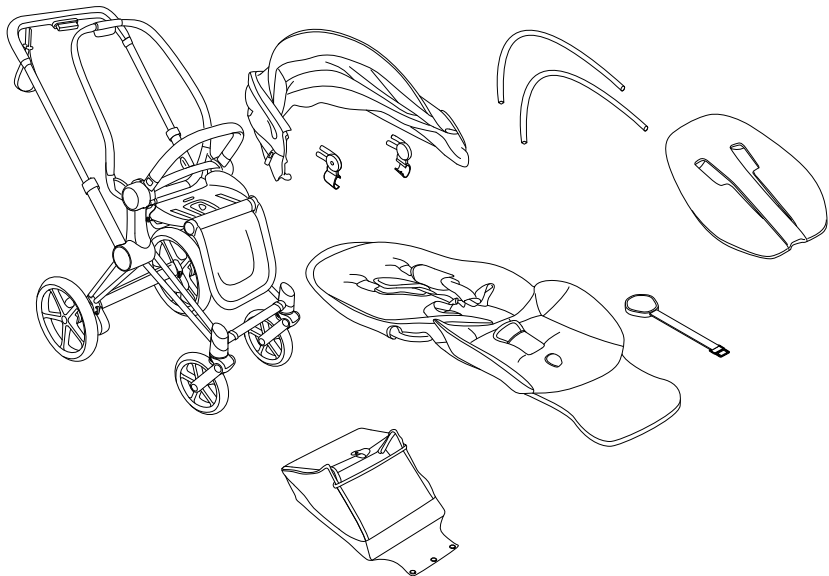

Troubleshooting



EN / DE / FR / ES	76
PT / IT / NL / PL	80
CS / SK / SL / HR	84
HU / SE / NO / FI	88
DA / ET / LV / LT	92
RU / UK / TR / EL	96
RO / IS / MT	100
AR / FA / YUE / CMN	104
JA / KO / BG / SR	108
MS / HI / TH / SQ	112
BS / ME / MK / HY / VI	116





**Indicator lights / Kontrolllampen /
Voyants d'indication / Luces indicadoras**

**Description / Beschreibung / Description /
Descripción**



Only the red light flashes.

Nur die rote Lampe blinkt.

Seul le voyant rouge clignote.

Solo parpadea la luz roja.



Red light is flashing and the LED spot next to the red light shines white permantly.

Die rote Lampe blinkt und der LED Spot neben der roten Lampe leuchtet permanent in weiß.

Le voyant rouge clignote et le spot LED à côté du voyant rouge émet une lumière blanche continue.

La luz roja parpadea y el foco LED junto a la luz roja está encendido en blanco de forma permanente.



Meaning / Bedeutung / Signification / Significado	Actions / Maßnahmen / Actions / Acciones
<p>The battery is empty. The stroller will decelerate permanently.</p> <p>Die Batterie ist leer. Der Kinderwagen wird permanent abgebremst.</p> <p>La batterie est vide. La poussette va freiner en permanence.</p> <p>La batería está vacía. El carrito frenará permanentemente.</p>	<p>Please turn off the ePriam & charge the battery!</p> <p>Bitte schalten Sie den ePriam aus und laden die Batterie auf!</p> <p>Veillez éteindre l'ePriam et charger la batterie !</p> <p>Apague ePriam y cargue la batería.</p>
<p>No signal from the handle bar. Support is not working anymore.</p> <p>Kein Signal von dem Schiebegriff. Unterstützung nicht mehr vorhanden.</p> <p>Pas de signal du guidon. L'assistance ne fonctionne plus.</p> <p>No hay señal procedente del manillar. El soporte no funciona.</p>	<p>Please fold & unfold the stroller. If the LED status remains the same please get in touch with your retailer!</p> <p>Bitte den Kinderwagen Zusammen- und Auffalten. Bleibt der LED Status der gleiche setzen Sie sich bitte mit Ihrem Händler in Verbindung.</p> <p>Veillez plier et déplier la poussette. Si l'état du voyant LED reste le même, veuillez contacter votre revendeur.</p> <p>Pliegue y despliegue el carrito. Si el LED de estado permanece igual, póngase en contacto con su distribuidor.</p>



**Indicator lights / Kontrolllampen /
Voyants d'indication / Luces indicadoras**

**Description / Beschreibung / Description /
Descripción**



Red light is flashing and all 4 white LED spots are shining permanently.

Die rote Lampe blinkt und alle 4 LED Spots leuchten permanent.

Le voyant rouge clignote et les 4 spots LED blancs sont allumés en permanence.

La luz roja parpadea y los 4 focos LED están encendidos permanentemente.



Meaning / Bedeutung / Signification / Significado	Actions / Maßnahmen / Actions / Acciones
<p>Error in calibration of the handle bar sensors. Support is not working anymore.</p> <p>Kalibrierungsfehler der Sensoren im Schiebegriff. Unterstützung nicht mehr vorhanden.</p> <p>Erreur de calibrage des capteurs du guidon. L'assistance électrique ne fonctionne plus.</p> <p>Error de calibración de los sensores del manillar. El soporte no funciona.</p>	<p>Please activate the foot brake and turn off the ePriam. Remove the weight on the handle bar and do not hold the handle bar. Now turn on the ePriam again. If the LED status remains the same please get in touch with your retailer.</p> <p>Bitte betätigen Sie die Feststellbremse und schalten den ePriam aus. Entfernen Sie das Gewicht vom Schiebegriff und halten Sie nicht den Schiebegriff fest. Schalten Sie nun den ePriam wieder an. Bleibt der LED Status der gleiche setzen Sie sich bitte mit Ihrem Händler in Verbindung.</p> <p>Veillez activer la pédale de frein et éteindre l'ePriam. Retirez la pression sur le guidon et ne le tenez pas. Allumez à nouveau l'ePriam. Si l'état du voyant LED reste le même, veuillez contacter votre revendeur.</p> <p>Por favor pise el pedal de freno y apague el ePriam. Retire el peso del manillar y no mantenga sujeto el manillar. A continuación, encienda de nuevo el ePriam. Si el LED de estado permanece igual, por favor póngase en contacto con su distribuidor.</p>



**Luzes indicadoras / Indicatori luminosi /
Indicatorlichtjes / Kontrolki**

Descrição / Descrizione / Beschrijving / Opis



Apenas a luz vermelha pisca.

Lampeggia solo la spia rossa.

Alleen het rode lichtje knippert.

Tylko czerwona lampka miga.



A luz vermelha pisca e o spot LED próximo da luz vermelha emite uma luminosidade branca permanente.

La spia rossa lampeggia e il LED accanto alla spia rossa diventa bianco e continuo.

Het rode licht knippert en de LED-spot naast het rode licht brandt voortdurend wit.

Czerwona kontrolka miga i punktowa lampka LED obok czerwonej kontroli świeci ciągle w białym kolorze.



Significado / Significato / Betekenis / Znaczenie	Ações / Azioni / Acties / Działania
<p>A bateria está descarregada. O carrinho diminuirá permanentemente a velocidade.</p> <p>La batteria è scarica. Il passeggino decelera in modo permanente.</p> <p>De batterij is leeg. De wandelwagen zal permanent vertragen.</p> <p>Akumulator jest rozładowany. Wózek zwolni na stałe.</p>	<p>Desligue o ePriam e carregue a bateria!</p> <p>Spegnere l'ePriam e ricaricare la batteria!</p> <p>Schakel de ePriam uit & laad de batterij op.</p> <p>Wyłącz ePriam i naładuj akumulator!</p>
<p>Ausência de sinal do guiador. O suporte já não funciona.</p> <p>Nessun segnale dalla barra dell'impugnatura. L'assistenza non funziona più.</p> <p>Geen signaal van de handgreep. De ondersteuning werkt niet meer.</p> <p>Brak sygnału z rączki. Wspomaganie nie działa.</p>	<p>Rebata e abra o carrinho. Se o estado do LED permanecer sem alterações, entre em contacto com o ponto de venda!</p> <p>Ripiegare e aprire il passeggino. Se lo stato del LED non cambia, contattare il rivenditore!</p> <p>Vouw de wandelwagen op en vouw hem opnieuw open. Neem contact op met uw verkooppunt als de LED-status niet verandert.</p> <p>Złóż i rozłóż wózek. Jeśli stan diody się nie zmieni, skontaktuj się ze sprzedawcą!</p>



**Luzes indicadoras / Indicatori luminosi /
Indicatorlichtjes / Kontrolki**

Descrição / Descrizione / Beschrijving / Opis



A luz vermelha pisca e os 4 spots LED brilham permanentemente.

La spia rossa lampeggia e tutti e 4 i LED bianchi sono accesi in modo continuo.

Het rode licht knippert en alle 4 witte LED-spots branden voortdurend.

Czerwona kontrolka miga i wszystkie 4 punktowe lampki LED świecą ciągle.



Significado / Significato / Betekenis / Znaczenie	Ações / Azioni / Acties / Działania
<p>Erro de calibragem dos sensores do guiador. O suporte já não funciona.</p> <p>Errore nella calibrazione dei sensori della barra dell'impugnatura. L'assistenza non funziona più.</p> <p>Fout bij het kalibreren van de sensoren van de handgreep. Ondersteuning werkt niet meer.</p> <p>Błąd kalibracji czujników w ręczce. Wspomaganie nie jest już dostępne.</p>	<p>Ative o travão de pedal e desligue o ePriam. Retire o peso do guiador e largue-o. Ligue novamente o ePriam. Se o estado do LED permanecer sem alterações, entre em contacto com o ponto de venda.</p> <p>Attivare il freno a pedale e spegnere l'ePriam. Rimuovere il peso dalla barra dell'impugnatura e non mantenerla. Ora accendere di nuovo l'ePriam. Se lo stato del LED non cambia, contattare il rivenditore.</p> <p>Activeer de voetrem en schakel de ePriam uit. Verwijder het gewicht op de handgreep en houd de handgreep niet vast. Schakel de ePriam opnieuw aan. Neem contact op met uw verkooppunt als de LED-status niet verandert.</p> <p>Uaktywnij hamulec postojowy i wyłącz ePriam. Usuń obciążenie z rączki i nie trzymaj jej. Włącz ePriam ponownie. Jeśli stan diody się nie zmieni, skontaktuj się ze sprzedawcą.</p>



**Svĕtelnĕ kontrolky / Svetelnĕ kontrolky /
Kontrolna svjetla / Jelzĕfĕnyek**

Popis / Popis / Opis / Opis



Blik pouze erven svĕtlo.

Blik iba erven svetlo.

Utripa samo rdea luka.

Samo crveno svjetlo treperi.



erven svĕtlo blik a LED vedle ervenho svĕtla trvale svit biele.

erven svetlo blik a LED veda ervenho svetla trvalo svieti na biele.

Rdea luka utripa, LED-dioda ob rdei lui pa stalno sveti belo.

Crveno svjetlo treperi, a LED dioda pored crvenog svjetla stalno svjetli bijelo.



Význam / Význam / Pomen / Značenje	Akce / Úkony / Dejanja / Mjere
<p>Baterie je vybitá. Kočárek se trvale zpomalí.</p> <p>Batéria je vybitá. Kočík sa natrvalo spomalí.</p> <p>Baterija je prazna. Voziček se bo trajno upočasnil.</p> <p>Baterija je prazna. Kolica se neprekidno usporavaju.</p>	<p>Vypněte prosím kočárek ePriam a nabijte baterii.</p> <p>Vypnite kočik ePriam a nabite batériu!</p> <p>Izklopite ePriam in napolnite baterijo!</p> <p>Molimo isključite ePriam i napunite bateriju!</p>
<p>Žádný signál z rukojeti. Podpora už nefunguje.</p> <p>Žiadny signál z rukoväte. Podpora už viac nefunguje.</p> <p>Ni signala z ročice. Podpora več ne deluje.</p> <p>Nema signala s ručice. Podrška više ne funkcioniра.</p>	<p>Prosím, složte a rozložte kočárek. Pokud se stav kontrolky LED nemění, obraťte se na svého prodejce.</p> <p>Prosím, složte a rozložte kočik. Ak sa stav LED nezmení, obráťte sa na svojho predajcu!</p> <p>Voziček zložite in razprite. Če ostane LED status enak, se obrnite na prodajalca!</p> <p>Molimo sklopite i rasklopite kolica. Ako LED status ostane isti, obratite se svom prodavaču!</p>



**Světelné kontrolky / Svetelné kontrolky /
Kontrolna svjetla / Jelzőfények**

Popis / Popis / Opis / Opis



Červené světlo bliká a všechny 4 bílé LED body svítí trvale.

Červené svetlo bliká a všetky 4 biele LED body svietia trvalo.

Rdeča lučka utripa in vse štiri bele LED-diode svetijo stalno.

Crveno svjetlo treperi i sve 4 bijele LED diode stalno svijetle.



Význam / Význam / Pomen / Značenje	Akce / Úkony / Dejanja / Mjere
<p>Chyba v kalibraci snímačů na rukojeti. Podpora už nefunguje.</p> <p>Chyba pri kalibrácii snímačov rukoväte. Podpora už viac nefunguje.</p> <p>Napaka umerjanja senzorjev ročice. Podpora več ne deluje.</p> <p>Pogreška u kalibraciji senzora ručice. Podrška više ne funkcionira.</p>	<p>Aktivujte nožní brzdu a vypněte kočárek ePriam. Odstraňte zátěž na rukojeti a pusťte ji. Nyní kočárek ePriam znovu zapněte. Pokud se stav kontrolky LED nemění, obraťte se na svého prodejce.</p> <p>Aktivujte nožnú brzdú a vypnite kočík ePriam. Odstráňte záťaž na rukoväti a pustite ju. Teraz kočík ePriam znovu zapnite. Ak sa stav LED nezmení, obráťte sa na svojho predajcu.</p> <p>Aktivirajte nožno zavoro in izklopite ePriam. Odstranite utež na ročici in ročice ne držite. Zdaj ePriam ponovno vklopite. Če ostane LED status enak, se obrnite na prodajalca.</p> <p>Molimo vas da aktivirate nožnu kočnicu i isključite ePriam. Uklonite uteg sa ručice i ne držite ručicu. Sada ponovo uključite ePriam. Ako LED status ostane isti, obratite se svom prodavaču!</p>



**Jelzőfények / Indikatorlampa /
Indikatorlys / Ilmaisinalot**

Leírás / Beskrivning / Beskrivelse / Kuvaus



Csak a piros fény villog.

Endast den röda lampan blinkar.

Bare det røde lyset blinker.

Vain punainen valo vilkkuu.



A piros fény villog és a piros fény melletti LED spot folyamatosan fehéren világít.

Den röda lampan blinkar och LED-lampan bredvid den röda lampan lyser med fast vitt sken.

Det røde lyset blinker og LED-lyset ved siden av det røde lyset skinner fast hvitt.

Punainen valo vilkkuu ja sen vieressä oleva LED-piste loistaa valkoisena pysyvästi.



Jelentés / Betydelse / Betydning / Tarkoitus	Eljárás / Åtgärde / Handlinger / Toiminnot
<p>Az akkumulátor lemerült. A babakocsi tartósan lassulni fog.</p> <p>Batteriet är tomt. Sittvagnen kommer att sakta farten och stanna.</p> <p>Batteriet er tomt. Barnevognen vil sakke farten permanent.</p> <p>Akku on tyhjä. Rattaat hidastuvat pysyvästi.</p>	<p>Kérjük, kapcsolja ki az ePriam-ot, és töltse fel az akkumulátort!</p> <p>Stäng av ePriam och ladda batteriet!</p> <p>Slå av ePriam og lad opp batteriet!</p> <p>Sammuta ePriam ja lataa akku!</p>
<p>Nem érkezik jel a tolókarból. A támogatás már nem működik.</p> <p>Ingen signal från handtaget. Ingen hjälp ges längre.</p> <p>Ingen signal fra håndtaket. Støtten fungerer ikke lenger.</p> <p>Ei signaalia ohjaustangosta. Tuki ei enää toimi.</p>	<p>Kérjük, csukja össze és nyissa ki a babakocsit. Ha a LED állapota változatlan marad, kérjük, vegye fel a kapcsolatot a kereskedővel!</p> <p>Fäll ihop och fäll sedan upp sittvagnen igen. Om LED-lampans status förblir oförändrad ber vi dig kontakta din återförsäljare.</p> <p>Fold barnevognen sammen og ut igjen. Hvis LED-statusen holder seg lik, ta kontakt med forhandleren!</p> <p>Taita ja avaa rattaat. Jos LED-tila pysyy samana, ota yhteyttä jälleenmyyjään!</p>



**Jelzőfények / Indikatorlampa /
Indikatorlys / Ilmaisinalot**

Leírás / Beskrivning / Beskrivelse / Kuvaus



A piros fény villog, és mind a 4 fehér LED spot folyamatosan világít.

Den röda lampan blinkar och alla 4 LED-lampor lyser med fast sken.

Det røde lyset blinker og alle de fire LED-lysene lyser permanent.

Punainen valo vilkkuu ja kaikki neljä valkoista LED-pistettä palavat valkoisina koko ajan.



Jelentés / Betydelse / Betydning / Tarkoitus	Eljárás / Åtgärde / Handlinger / Toiminnot
<p>A tolókar érzékelőinek kalibrálása meghibásodott. A támogatás már nem működik.</p> <p>Fel vid kalibrering av handtagets givare. Ingen hjälper längre.</p> <p>Feil i kalibrering av håndtakssensoren. Støtten fungerer ikke lenger.</p> <p>Ohjaustangon antureiden kalibrointivirhe. Tuki ei enää toimi.</p>	<p>Aktiválja a lábféket, és kapcsolja ki az ePriam-ot. Távolítsa el a súlyt a tolókarról, és ne tartsa a tolókart. Most kapcsolja be újra az ePriam-ot. Ha a LED állapot a változatlan marad, kérjük, vegye fel a kapcsolatot a kereskedővel.</p> <p>Aktivera fotbromsen och stäng av ePriam. Ta bort vikten från handtaget och håll sedan inte i handtaget. Slå på ePriam igen. Om LED-lampornas status förbli oförändrade ber vi dig kontakta din återförsäljare.</p> <p>Aktiver fotbromsen og slå av ePriam. Fjern vekten på håndtaket og ikke hold i håndtaket. Slå deretter på ePriam på nytt. Hvis LED-statusen holder seg lik, ta kontakt med forhandleren.</p> <p>Aktivoi jalkajarru ja sammuta ePriam. Poista paino ohjaustangosta äläkä pidä siitä kiinni. Kytke nyt ePriam uudelleen päälle. Jos LED-tila pysyy samana, ota yhteyttä jälleenmyyjään..</p>



Kontrollamper / Indikaatoruled / Gaismas indikatori / Indikatoriaus lemputės

Beskrivelse / Kirjeldus / Apraksts / Aprašymas



Kun den røde lampe lyser.

Ainult punane lamp vilgub.

Mirgo vienīgi sarkanās gaismas indikators.

Mirksi tik raudona lemputē.



Den røde lampe blinker, og lysdioden ved siden af den røde lampe lyser hele tiden hvidt.

Punane lamp vilgub ja selle kõrval olev valge LED-punkt põleb pidevalt.

Mirgo sarkanās gaismas indikators un blakus esošais LED izgaismojas baltā krāsā.

Mirksi raudona lemputē ir baltai šviečia šviesos diodas šalia raudonos lemputės.



Betydning / Tähendus / Skaidrojums / Reikšmė	Handler / Toiming / Darbība / Veiksmāi
<p>Batteriet er tomt. Klapvognen vil bremse permanent.</p> <p>Aku on tühi. Jalutuskäru kiirus langeb püsivalt.</p> <p>Akumulators ir izlādējies. Bērnu ratiņi samazinās ātrumu.</p> <p>Nusilpo akumulatorius. Vežimēlis negrīžtamai sulētēs.</p>	<p>Sluk for ePriam og oplad batteriet!</p> <p>Lūlitage ePriam välja ja laadige akut.</p> <p>Lūdzu, izslēdziet ePriam un uzlādējiet akumulatoru!</p> <p>Išjunkite „ePriam“ ir įkraukite akumulatorių!</p>
<p>Intet signal fra styret. Support ikke tilgængelig mere.</p> <p>Käepidemelt ei tule signaali. Tugi ei toimi enam.</p> <p>No roktura netiek saņemts signāls. Atbalsts nedarbojas.</p> <p>Nēra signalo iš rankenos. Atrama nebeveikia.</p>	<p>Fold klapvognen sammen og ud igen. Hvis status for lysdioderne herefter er den samme, skal du kontakte forhandleren!</p> <p>Pange jalutuskäru kokku ja võtke uuesti lahti. Kui LED-punkt põleb endiselt samamoodi, pöörduge toote müüja poole!</p> <p>Lūdzu, salokiet un atlokiet bērnu ratiņus. Ja LED statuss nemainās, lūdzu, sazinieties ar izplatītāju!</p> <p>Sulankstykite ir išlankstykite vežimėlį. Jei šviesos diodas išlieka toks pats, kreipkitės į pardavėją!</p>



**Kontrolllamper / Indikaatorituled / Gaismas
indikatori / Indikatoriaus lemputės**

Beskrivelse / Kirjeldus / Apraksts / Aprašymas



Den røde lampe blinker, og alle 4 hvide lysdioder lyser hele tiden.

Punane lamp vilgub ja kõik neli valget LED-punkti põlevad pidevalt.

Mirgo sarkanās gaismas indikators un visi 4 LED izgaismojas baltā krāsā.

Mirksi raudona lemputė ir visi 4 balti šviesos diodai nuolat dega.



Betydning / Tähendus / Skaidrojums / Reikšmė	Handlering / Toiming / Darbība / Veiksmāi
<p>Fejl i kalibreringen af styrets sensorer. Support ikke tilgængelig mere.</p>	<p>Aktivér fodbremseren og sluk for ePriam. Fjern vægten på styret og hold ikke ved styret. Tænd nu for ePriam igen. Hvis status for lysdioderne herefter er den samme, skal du kontakte forhandleren!</p>
<p>Käepideme andurite kalibreerimisviga. Tugi ei toimi enam.</p>	<p>Rakendage jalgpidor ja lülitage ePriam välja. Eemaldage käepidemelt raskus ja ärge hoidke käepidemest kinni. Seejärel lülitage ePriam uuesti sisse. Kui LED-punkt põleb endiselt samamoodi, pöörduge toote müüja poole.</p>
<p>Radusies roktura sensora kalibrācijas kļūme. Atbalsts nedarbojas.</p>	<p>Lūdzu, aktivizējiet kājas bremzi un izslēdziet ePriam. Atslogojiet rokturi un neturiet to. No jauna ieslēdziet ePriam. Ja LED statuss nemainās, lūdzu, sazinieties ar izplatītāju.</p>
<p>Rankenos jutiklių kalibravimo klaida. Atrama nebeveikia.</p>	<p>Ijunkite kojinių stabdį ir išjunkite „ePriam“. Perkelkite svorį nuo rankenos ir nelaikykite jos. Dabar vėl įjunkite „ePriam“. Jei šviesos diodas išlieka toks pats, kreipkitės į pardavėją.</p>



Световые индикаторы / Світлові індикатори / Gösterge Işıkları / Φωτεινές ενδείξεις

Описание / Опис / Açıklama / Περιγραφή



Мигает только красный световой индикатор.

Світиться тільки червоний індикатор.

Sadece kırmızı ışık yanıp söner.

Μόνο το κόκκινο λαμπάκι αναβοσβήνει.



Красный световой индикатор мигает, а светодиод рядом с красным световым индикатором постоянно горит белым.

Червоний індикатор мигає, а світлодіод біля червоного індикатора постійно світиться білим.

Kırmızı ışık yanıp sönüyor ve kırmızı ışığın yanındaki LED sürekli olarak beyaz yanıyor.

Το κόκκινο λαμπάκι αναβοσβήνει και το σποτάκι LED δίπλα στο κόκκινο φωτάκι είναι σταθερά αναμμένο.



Значение / Значення / Anlami / Σημασία	Действия / Дії / Eylemler / Ενέργειες
<p>Акумулятор разряжен. Детская коляска полностью сбросит скорость.</p> <p>Акумулятор розряджений. Візок постійно уповільнюватиметься.</p> <p>Pil boş. Bebek arabasının hızı sürekli azalacaktır.</p> <p>Η μπαταρία είναι άδεια. Το καροτσάκι θα σταματήσει μόνη.</p>	<p>Выключите систему ePriam и зарядите аккумулятор!</p> <p>Вимкніть ePriam та зарядіть акумулятор!</p> <p>ePriam özelliğini kapatın ve pili şarj edin!</p> <p>Απενεργοποιήστε το ePriam και αντικαταστήστε τη μπαταρία!</p>
<p>Нет сигнала от рукоятки. Поддержка больше не работает.</p> <p>Відсутній сигнал з рукоятки. Опора більше не діє.</p> <p>Kulp çubuğunda sinyal yok. Destek artık çalışmıyor.</p> <p>Δεν υπάρχει σήμα από την χειρολαβή. Η υποστήριξη δεν δουλεύει πλέον.</p>	<p>Сложите и затем разложите детскую коляску обратно. Если светодиодный индикатор останется в том же состоянии, свяжитесь с продавцом!</p> <p>Складіть та розкладіть візок. Якщо світлодіод світиться в тому самому режимі, зверніться до свого дилера!</p> <p>Bebek arabasını katlayıp tekrar açın. LED durumu aynı kalmaya devam ederse lütfen satıcınızla iletişime geçin!</p> <p>Διπλώστε και ξεδιπλώστε το καροτσάκι. Αν η κατάσταση LED παραμένει ίδια, επικοινωνήστε με τον πωλητή σας!</p>



Световые индикаторы / Світлові
індикатори / Gösterge Işıkları /
Φωτεινές ενδείξεις

Описание / Опис / Açıklama / Περιγραφή



Красный световой индикатор мигает, и все 4 белых светодиода постоянно горят.

Червоний індикатор мигає, а всі 4 світлодіоди постійно світяться білим.

Kırmızı ışık yanıp sönüyor ve 4 beyaz LED'in tamamı sürekli olarak yanıyor.

Το κόκκινο λαμπάκι αναβοσβήνει και τα τέσσερα σποτάκια LED είναι σταθερά αναμμένα.



Значение / Значення / Anlami / Σημασία	Действия / Дії / Eylemler / Ενέργειες
<p>Ошибка калибровки сенсоров рукоятки. Поддержка больше не работает.</p> <p>Πомилка калібрування датчиків рукоятки. Опора більше не діє.</p> <p>Kulp çubuğu sensörlerinin kalibrasyonunda hata var. Destek artık çalışmıyor.</p> <p>Σφάλμα στη βαθμονόμηση των αισθητήρων της χειρολαβής. Η υποστήριξη δεν λειτουργεί πλέον.</p>	<p>Активируйте педальный тормоз и выключите ePriam. Снимите вес с рукоятки и не касайтесь рукоятки. Затем снова включите систему ePriam. Если светодиодный индикатор останется в том же состоянии, свяжитесь с продавцом!</p> <p>Активуйте педальні гальма та вимкніть ePriam. Зніміть навантаження з рукоятки и не тримайтеся за неї. Тепер знову вимкніть ePriam. Якщо світлодіод світиться в тому самому режимі, зверніться до свого дилера.</p> <p>Lütfen ayak frenini etkinleştirin ve ePriam'ı kapatın. Kulp çubuğundaki yükü kaldırın ve kulp çubuğunu tutmayın. Şimdi ePriam'ı tekrar açın. LED durumu aynı kalırsa lütfen satıcınızla iletişime geçin.</p> <p>Ενεργοποιήστε το πεντάλ του φρένου και απενεργοποιήστε το ePriam. Αφαιρέστε το βάρος από τη χειρολαβή και σταματήστε να την κρατάτε. Τώρα ενεργοποιήστε ξανά το ePriam. Εάν η κατάσταση LED παραμένει ίδια, παρακαλούμε επικοινωνήστε με τον πωλητή σας.</p>



Lumini indicatoare / Stefnuljós / Lampu Penunjuk

Descriere / Lýsing / Keterangan



Doar lumina roșie clipește.

Aðeins rauða ljósið blikkar.

Hanya lampu merah berkelip.



Lumina roșie clipește și LED-ul de lângă lumina roșie strălucește alb permanent.

Rauða ljósið blikkar og LED stæðan við hlið rauða ljósins skín hvít varanlega.

Lampu merah berkelip dan cahaya LED putih di sebelah lampu merah bernyala.



Sens / Merking / Maksud	Açtioni / Aðgerð / Tindakan
<p>Bateria este goală. Căruciorul va decelera permanent.</p> <p>Rafhlaðan er tóm. Vagninn mun hægja á sér þar til hann stöðvast.</p> <p>Bateri haus. Kereta sorong akan terus perlahan.</p>	<p>Vă rugăm să opriți ePriam și să încărcați bateria!</p> <p>Vinsamlegast slökkvið á ePriam og hlaðið rafhlöðuna!</p> <p>Sila matikan ePriam & cas bateri!</p>
<p>Fără semnal de la mâner. Suportul nu mai funcționează.</p> <p>Ekkert merki berst frá handfangi. Stuðningur virkar ekki lengur.</p> <p>Tiada isyarat daripada bar pemegang. Sokongan tidak lagi berfungsi.</p>	<p>Vă rugăm să pliați și să desfaceți căruciorul. Dacă starea LED-ului rămâne aceeași, vă rugăm să luați legătura cu vânzătorul!</p> <p>Vinsamlegast leggjið saman og setjið upp vagninn. Ef LED merking er enn eins þá vinsamlegast hafið samband við söluaðila.</p> <p>Sila lipat & buka lipatan kereta sorong. Jika cahaya LED kekal sama, hubungi pekedai anda!</p>



Lumini indicatoare / Stefnuljós / Lampu Penunjuk



Descriere / Lýsing / Keterangan

Lumina roșie clipește și toate cele 4 LED-uri albe strălucesc permanent.

Rauða ljósið blikkar og allar 4 hvítu LED perurnar skína varanlega.

Lampu merah berkelip dan keempat-empat cahaya LED putih bernyala.



Sens / Merking / Maksud	Acțiuni / Aðgerð / Tindakan
<p>Eroare în calibrarea senzorilor mânerului. Suportul nu mai funcționează.</p> <p>Villa við stillingu á skynjara í handfangi. Stuðningur virkar ekki lengur.</p> <p>Ralat semasa menentukur penderia bar pemegang. Sokongan tidak lagi berfungsi.</p>	<p>Vă rugăm să activați frâna de picior și să opriți ePriam. Îndepărtați greutatea de pe mâner și nu țineți mâna pe mâner.</p> <p>Acum porniți din nou ePriam.</p> <p>Dacă starea LED-ului rămâne aceeași, vă rugăm să luați legătura cu vânzătorul.</p> <p>Vinsamlegast virkið fótabremsuna og slökkvið á ePriam. Fjarlægjið lóðin af handfanginu og ekki halda í handfangið. Kveikið nú á ePriam aftur. Ef LED merking er enn sú sama þá vinsamlegast hafið samband við söluaðila.</p> <p>Sila aktifkan brek kaki dan matikan ePriam.</p> <p>Alihkan pemberat pada bar pemegang dan jangan pegang bar pemegang.</p> <p>Sekarang, hidupkan ePriam sekali lagi.</p> <p>Jika cahaya LED masih tidak berubah, sila hubungi pekedai anda.</p>



چراغ‌های نشانگر / أضواء المؤشر / 指示灯 / 指示灯

الوصف / شرح / 說明 / 说明



الضوء الأحمر فقط يومض.
فقط چراغ قرمز چشمک می‌زند.
只有紅燈閃爍。
只有红灯闪烁。



المجاورة له تضيء باللون الأبيض بشكل دائم LED الضوء الأحمر يومض وبقعة.
کنار چراغ قرمز دائماً به رنگ سفید می‌درخشد LED نور قرمز چشمک می‌زند و نقطه.
紅燈閃爍，紅燈旁邊的 LED 光點常亮白色。
红灯闪烁，红灯旁边的 LED 光点常亮白色。



المعنى / مفهوم / 意義 / 意义	الإجراءات / اقدامات / 操作 / 操作
<p>البطارية فارغة. سرعة عربة الأطفال ستتباطأ بشكل دائم.</p> <p>باترى خالى است. سرعت كالسكه متناوبا كاهش می یابد.</p> <p>電池沒電了。嬰兒車將永久減速。</p> <p>電池沒電了。嬰兒車將永久減速。</p>	<p>وشحن البطارية ePriam يُرجى إيقاف تشغيل!</p> <p>را خاموش و باترى را شارژ كنيد ePriam لطفا!</p> <p>請關閉 ePriam 並給電池充電!</p> <p>請关闭 ePriam 并給電池充電!</p>
<p>لا توجد إشارة من شريط المقبض. لن يعمل الدعم بعد الآن.</p> <p>هیچ سیگنالی از دسته دریافت نمی شود. پشتیبانی دیگر کارایی ندارد.</p> <p>手柄杆沒有信號。 支架不起作用了。</p> <p>手柄杆没有信号。 支架不起作用了。</p>	<p>يُرجى طي عربة الأطفال ثم فتحها. كما هي، فيرجى الاتصال ببناع التجزئة الذي تتعامل LED إذا ظلت حالة! معه</p> <p>لطفا كالسكه را تا و دوباره باز كنيد. ثابت ماند، لطفا با فروشنده تماس بگیريد LED اگر وضعیت!</p> <p>請折疊然後再展開嬰兒車。 如果 LED 燈狀態保持不變，請與您的經銷商聯繫！</p> <p>請折疊然後再展開嬰兒車。 如果 LED 燈狀態保持不變，請與您的經銷商聯繫！</p>



أضواء المؤشر / چراغ‌های نشانگر / 指示灯 / 指示灯

الوصف / شرح / 說明 / 说明



البيضاء الأربعة تضيء بشكل دائم LED الضوء الأحمر يومض وجميع نقاط.

به طور دائمی می‌درخشند LED چراغ قرمز چشمک می‌زند و هر 4 نقطه سفید.

紅燈閃爍，所有 4 個白色 LED 燈光點將永久閃爍。

红灯闪烁，所有 4 个白色 LED 灯光点将永久闪烁。



المعنى / مفهوم / 意義 / 意义	الإجراءات / اقدامات / 操作 / 操作
<p>خطأ في معايرة مستشعرات شريط المقبض. لن يعمل الدعم بعد الآن.</p> <p>خطا در کالیبراسیون حسگرهای دسته. پشتیبانی دیگر کارایی ندارد.</p> <p>手柄杆感測器校準時出錯。支架不起作用了。</p> <p>手柄杆传感器校准时出错。支架不起作用了。</p>	<p>ePriam، يُرجى تنشيط مكابح القدم وإيقاف تشغيل. قم بإزالة الوزن الموجود على شريط المقبض ولا تمسك به. مرة أخرى ePriam قم الآن بتشغيل. كما هي، يرجى الاتصال ببائع التجزئة الذي تتعامل LED إذا ظلت حالة. معه</p> <p>را خاموش کنید ePriam لطفاً ترمز دستي را فعال کرده و، وزن را از روی دسته بردارید و دسته را نگیرید. را روشن کنید ePriam حالا دوباره. تغییر نکرد، لطفاً با فروشنده تماس بگیرید LED اگر وضعیت.</p> <p>請啟動腳剎並關閉 ePriam。卸下手柄杆上的重物， 不要握住手柄杆。現在再次打開 ePriam。如果 LED 燈狀態保持不變，請與您的經銷商聯繫。</p> <p>请启动脚刹并关闭 ePriam。卸下手柄杆上的重物， 不要握住手柄杆。现在再次打开 ePriam。如果 LED 灯状态保持不变，请与您的经销商联系。</p>



インジケータ ランプ / 표시등 /
Светлинни индикатори / Kontrolne
lampice

説明 / 설명 / Описание / Opis



赤いランプだけ点滅する。

붉은 등만 깜빡임.

Мига само червената светлина.

Samo crvena lampica treperi.



赤いランプが点滅し、赤色のランプの隣にあるLEDランプは
白く連続点灯する。

붉은 등이 깜빡이고 붉은 등 옆의 LED 부분에 흰색 불이
계속 켜져 있음.

Червената светлина мига, а светодиодът до червената
светлина свети постоянно в бяло.

Crvena lampica treperi, a LED dioda pored crvene lampice
stalno svetli belo.



意味 / 의미 / Значение / Značenje	対応策 / 동작 / Действия / Mere
<p>バッテリーの残量がありません。ベビーカーは減速して止まります。</p> <p>배터리가 없음. 유아차의 속도가 영구적으로 줄어 듭니다.</p> <p>Батерията е изтощена. Детската количка ще се движи все по-бавно.</p> <p>Baterija je prazna. Kolica se neprekidno usporavaju.</p>	<p>ePriamの電源を切って充電してください。</p> <p>ePriam을 끄고 배터리를 충전하세요!</p> <p>Моля изключете ePriam и заредете батерията!</p> <p>Molimo isključite ePriam i napunite bateriju!</p>
<p>ハンドルバーからのシグナルがありません。支持機能が動作していません。</p> <p>핸들 바에 신호가 없음. 서포트가 더 이상 작동하지 않음.</p> <p>Липсва сигнал от дръжката. Опората вече не работи.</p> <p>Nema signala sa ručice. Podrška više ne funkcioniše.</p>	<p>ベビーカーを折りたたんでから広げてください。LEDランプの状態が変わらない場合は、お買い上げの店舗にお問い合わせください。</p> <p>유아차를 접었다가 펴세요. LED가 계속 같은 상태로 유지된다면 판매점에 문의하세요!</p> <p>Моля сгънете и разгънете детската количка. Ако статусът на светодиода остане същият, моля свържете се с Вашия дистрибутор!</p> <p>Molimo sklopite i rasklopite kolica. Ako LED status ostane isti, obratite se svom prodavcu!</p>



インジケータ ランプ / 표시등 /
Светлинни индикатори / Kontrolne
lampice

説明 / 설명 / Описание / Opis



赤いランプが点滅し、4つの白いLEDランプは連続点灯している。

붉은 등이 깜빡이고 4개의 흰색 LED에 모두 불이 켜져 있음.

Червената светлина мига, а всички четири светодиода светят постоянно.

Crvena lampica treperi i sve 4 bele LED diode kontinuirano svetle.



意味 / 의미 / Значение / Značenje	対応策 / 동작 / Действия / Mere
<p>ハンドルバーセンサーのキャリブレーション中にエラーが発生しました。支持機能が動作していません。</p> <p>핸들 바 센서의 보정에 오류가 있음. 서포트가 더 이상 작동하지 않음.</p> <p>Грешка в калибрирането на датчиците на дръжката. Поддръжката вече не работи.</p> <p>Greška u kalibraciji senzora ručice. Podrška više ne funkcionise.</p>	<p>フットブレーキを作動させてePriamの電源を切ってください。ハンドルバーに荷重がかからないようにし、ハンドルバーから手を離してください。次にePriamの電源を入れなおしてください。LEDランプの状態が変わらない場合は、お買い上げの店舗にお問い合わせください。</p> <p>풋 브레이크를 작동하고 ePriam을 끄세요. 핸들 바의 하중을 제거하고 핸들 바를 잡지 마세요. 이제 ePriam을 다시 켜세요. LED가 계속 같은 상태로 유지된다면 판매점에 문의하세요.</p> <p>Моля активирайте крачната спирачка и изключете ePriam. Отстранете тежестите от дръжката и не я дръжете. Включете отново ePriam. Ако статусът на светодиодите остане същият, моля свържете се с Вашия дистрибутор.</p> <p>Aktivirajte nožnu kočnicu i isključite ePriam. Uklonite teg sa ručice i ne držite ručicu. Sada ponovo uključite ePriam. Ako LED status ostane isti, obratite se svom prodavcu!</p>



Lampu Penunjuk / संकेतक बतियाँ / ไฟแสดงสถานะ / Dritat treguese

Keterangan / विवरण / คำอธิบาย / Përshkrim



Hanya lampu merah berkelip.

केवल लाल बत्ती जलती है।

มีเพียงไฟสีแดงกะพริบ

Vetëm drita e kuqe pulson.



Lampu merah berkelip dan cahaya LED putih di sebelah lampu merah bernyal.

लाल बत्ती जल रही है और लाल बत्ती के बगल में स्थित LED स्थायी रूप से सफेद है।

ไฟสีแดงกะพริบและจุด LED ข้างไฟสีแดงจะสว่างเป็นสีขาอย่างถาวร

Drita e kuqe pulson dhe spoti LED pas dritës së kuqe qëndron e ndezur në ngjyrë të bardhë.



Maksud / अर्थ / ความหมาย / Çfarë do të thotë	Tindakan / कार्यवाई / การดำเนินการ / Veprimet
<p>Bateri haus. Kereta sorong akan terus perlahan.</p> <p>बैटरी खाली है। स्ट्रोलर स्थायी रूप से धीमा हो जाएगा।</p> <p>แบตเตอรี่หมด รถเข็นเด็กจะชะลอความเร็วอย่างถาวร</p> <p>Bateria është bosh. Karroca do të ngadalësohet përfundimisht.</p>	<p>Sila matikan ePriam & cas baterai!</p> <p>कृपया ePriam बंद करें और बैटरी चार्ज करें!</p> <p>โปรดปิด ePriam และชาร์จแบตเตอรี่!</p> <p>Ju lutem fikeni ePriam dhe karikoni baterinë!</p>
<p>Tiada isyarat daripada bar pemegang. Sokongan tidak lagi berfungsi.</p> <p>हैंडल बार से कोई संकेत नहीं। सपोर्ट अब काम नहीं कर रहा है।</p> <p>ไม่มีสัญญาณจากแฮนด์บาร์ การสนับสนุนไม่สามารถใช้ได้อีกต่อไป</p> <p>Nuk ka sinjal nga shufra e dorezës. Mbështetja nuk funksionon më.</p>	<p>Sila lipat & buka lipatan kereta sorong. Jika cahaya LED kekal sama, hubungi pekedai anda!</p> <p>कृपया स्ट्रोलर को मोड़ें और फिर खोलें। यदि LED की स्थिति समान रहती है तो कृपया अपने खुदरा विक्रेता से संपर्क करें!</p> <p>กรุณาพับและกางรถเข็นออก หากสถานะ LED ยังคงเหมือนเดิม โปรดติดต่อผู้ค้าปลีกของคุณ!</p> <p>Ju lutem paloseni dhe shpaloseni karrocën. Nëse gjendja e dritës LED mbetet njëjëlloj, ju lutemi të kontaktoni shitësin!</p>



**Lampu Penunjuk / संकेतक बतियाँ / ไฟแสดง
สถานะ / Dritat treguese**



Keterangan / विवरण / คำอธิบาย / Përshkrim

Lumina roșie clipește și toate cele 4 LED-uri albe strălucesc permanent.

लाल बत्ती जल रही है और सभी 4 सफेद LED स्पॉट स्थायी रूप से जल रहे हैं।

ไฟสีแดงกะพริบและจุด LED สีขาวทั้ง 4 จุดสว่างอย่างถาวร

Drita e kuqe pulson dhe të 4 spotet LED qëndrojnë ndezur.



Maksud / अर्थ / ความหมาย / Çfarë do të thotë	Tindakan / कार्रवाई / การดำเนินการ / Veprimet
<p>Eroare în calibrarea senzorilor mânerului. Suportul nu mai funcționează.</p> <p>हैंडल बार सेंसर के कैलीब्रेशन में त्रुटि। सपोर्ट अब काम नहीं कर रहा है।</p> <p>เกิดข้อผิดพลาดในการปรับเทียบเซ็นเซอร์ของแฮนด์บาร์ การสนับสนุนไม่สามารถใช้ได้อีกต่อไป</p> <p>Gabim në kalibrimin e sensorëve të shufrës mbajtëse. Mbështetja nuk punon më.</p>	<p>Vă rugăm să activați frâna de picior și să opriți ePriam. Îndepărtați greutatea de pe mâner și nu țineți mâna pe mâner. Acum porniți din nou ePriam. Dacă starea LED-ului rămâne aceeași, vă rugăm să luați legătura cu vânzătorul.</p> <p>कृपया फुट ब्रेक को सक्रिय करें और ePriam को बंद करें। हैंडल बार से भार हटा दें और हैंडल बार को न पकड़ें। अब ePriam को फिर से चालू करें। यदि LED की स्थिति समान रहती है तो कृपया अपने खुदरा विक्रेता से संपर्क करें।</p> <p>โปรดเปิดใช้งานเบรกเท้าและปิด ePriam จากนั้นนำตัวถ่วงน้ำหนักบนแฮนด์บาร์ออกและอย่าจับแฮนด์บาร์ คราวนี้เปิด ePriam อีกครั้ง หากสถานะ LED ยังคงเหมือนเดิม โปรดติดต่อผู้ค้าปลีกของคุณ</p> <p>Ju lutem aktivizoni frenën e këmbës dhe fikeni ePriam. Hiqeni peshën në dorezën mbajtëse dhe mos e mbani dorezën mbajtëse. Tani ndizeni ePriam përsëri. Nëse statusi i dritës LED nuk ndryshon, ju lutem kontaktoni shitësin.</p>



**Kontrolne lampice / Kontrolne lampice /
Индикаторски светла / Յուշիչ լույսեր**

Opis / Opis / Опис / Ավարագիր



Samo crvena lampica treperi.

Samo crvena lampica treperi.

Трепка само црвеното светло.

Միայն կարմիր լույսն է թարթում:

Chỉ có đèn đỏ nhấp nháy.



Crvena lampica treperi, a LED dioda pored crvene lampice stalno svijetli bijelo.

Crvena lampica treperi, a LED dioda pored crvene lampice stalno svijetli bijelo.

Արևոտո սեղո տրեքո ու LED-տոչկոտո քո սե ոոոգո ոո ուրեոտո սեղո սեոո քոսոյոո ոո ոեո ոոյո.

Կարմիր լույսը թարթում է, իսկ կարմիր լույսի կողքին գտնվող LED կետը մշտապես սպիտակ է:

Đèn đỏ nhấp nháy và tín hiệu LED bên cạnh đèn đỏ sáng trắng.



Նշաճեյե / Značenje / Значење / Լշանակություն	Mjere / Мјере / Дејства / Գործողություններ
<p>Baterija je prazna. Kolica se neprekidno usporavaju.</p> <p>Baterija je prazna. Kolica se neprekidno usporavaju.</p> <p>Батеријата е празна. Количката ќе се забави трајно.</p> <p>Մարտկոցը դատարկ է: Մանկասայլակը դանդաղելով կանգ կառնի:</p> <p>Hết pin. Xe đầy sẽ luôn đi chậm lại. .</p>	<p>Molimo isključite ePriam i napunite bateriju!</p> <p>Molimo isključite ePriam i napunite bateriju!</p> <p>Исклучете го ePriam и наполнете ја батеријата!</p> <p>Խնդրում ենք անջատել ePriam-ը և լիցքավորել մարտկոցը:</p> <p>Vui lòng tắt ePriam & sạc pin!</p>
<p>Nema signala s ručice. Podrška više ne funkcioniše.</p> <p>Nema signala sa ručice. Podrška više ne funkcioniše.</p> <p>Нема сигнал од рачката. Поддршката повеќе не функционира.</p> <p>Բռնակի ձողից ազդանշան չկա: Աջակցությունն այլևս չի գործում:</p> <p>Không có tín hiệu từ thanh tay lái. Phần đỡ không còn có tác dụng.</p>	<p>Molimo sklopite i rasklopite kolica. Ako LED status ostane isti, obratite se svom prodavcu!</p> <p>Molimo sklopite i rasklopite kolica. Ako LED status ostane isti, obratite se svom prodavcu!</p> <p>Տկոպե՛տե յա և օճորե՛տե յա քոլիքատա. Աքո ստատուս ու ԼԵԴ թոճոլճի յա ռաքոճաճիճակը մաա Նոյլը, կաաճճեք ձեր ճաճառողի հետ:</p> <p>Vui lòng gập lại rồi mở xe đầy ra. Nếu trạng thái LED vẫn không đổi, vui lòng liên lạc với bên bán lẻ của quý vị!</p>



**Kontrolne lampice / Kontrolne lampice /
Индикаторски светла / Ցուցիչ լույսեր /
Đèn của bộ phận đèn chỉ báo**

Opis / Opis / Опис / Արարագիր / Mô tả



Crvena lampica treperi i sve 4 bijele LED diode stalno svijetle.

Crvena lampica treperi i sve 4 bijele LED diode stalno svijetle.

Црвеното светло трепка и сите 4 бели ЛЕД-точки светат постојано.

Կարմիր լույսը թարթում է, և բոլոր 4 սպիտակ LED կետերը մշտապես վառվում են:

Đèn đỏ nhấp nháy và tất cả 4 tín hiệu LED màu trắng bật sáng đều.



Značenje / Značenje / Значење / Լշանակություն / Ý nghĩa	Mjere / Mjere / Дејства / Գործողություններ / Việc cần làm
<p>Greška u kalibraciji senzora ručice. Podrška više ne funkcioniše.</p>	<p>Aktivirajte nožnu kočnicu i isključite ePriam. Uklonite teg sa ručice i ne držite ručicu. Sada ponovo uključite ePriam. Ako LED status ostane isti, obratite se svom prodavcu!</p>
<p>Greška u kalibraciji senzora ručice. Podrška više ne funkcioniše.</p>	<p>Aktivirajte nožnu kočnicu i isključite ePriam. Uklonite teg sa ručice i nemojte držati ručicu. Sada ponovo uključite ePriam. Ako LED status ostane isti, obratite se svom prodavcu!</p>
<p>Грешка при калибрација на сензорите на рачката. Поддршката повеќе не работи.</p>	<p>Активирајте ја ножната сопирачка и исклучете го ePriam. Престанете да ја притискате и да ја држите рачката. Сега, вклучете го ePriam повторно. Ако статусот на ЛЕД-точката остане ист, контактирајте со продавачот.</p>
<p>Բռնակի ձողի տվիների կալիբրացիայի սխալ: Աջակցությունն այլևս չի գործում:</p>	<p>Խնդրում ենք միացնել ոտնաթաթի արգելակը և անջատել ePriam-ը: Հեռացրեք բռնակի ձողի ծանրությունը և մի պահեք բռնակի ձողը: Այժմ նորից միացրեք ePriam-ը: Եթե LED-ի կարգավիճակը մնում է նույնը, կապվեք ձեր մանրածախ վաճառողի հետ:</p>
<p>Lỗi xác định các bộ cảm biến trên thanh tay lái. Phần đỡ không còn có tác dụng.</p>	<p>Vui lòng kích hoạt phanh chân và tắt ePriam. Tránh để lên tay lái và không nắm lấy thanh tay lái. Bây giờ bật lại ePriam. Nếu trạng thái LED vẫn không đổi, vui lòng liên lạc với bên bán lẻ của quý vị.</p>



CYBEX GmbH
Riedingerstr. 18 | 95448 Bayreuth | Germany
+49 (0) 921-78 511-0 | info@cybex-online.com

www.cybex-online.com

