















LEMO BOUNCER

	Preparing the bouncer	7
	Easy assamble and dissassamble	8
	Using the harness system	10
	Adjusting the backrest	12
	Removing the fabric	13
	Usage on highchair	20
	Usage as bouncing childrens chair	32

	Vorbereitung der Wippe	7
	Montage und Demontage	8
	Verwendung des Gurtsystems	10
	Einstellen der Sitzposition	12
	Abnehmen des Bezuges	13
	Verwendung auf dem Hochstuhl	20
	Verwendung als wippender Kinderstuhl	32



Préparation du transat

7



Montage et démontage facile

8



Utilisation du harnais

10



Réglage du dossier

12



Retirer la housse

13









Utilisation sur chaise haute

20



Utilisation chaise enfant

32

	Preparación del balancín	7
	Fácil montaje y desmontaje	8
	Uso del sistema de arneses	10
	Ajuste de la posición del asiento	12
	Retirar la funda de la silla	13
	Uso en la trona	20
	Uso como silla infantil basculante	32



LEMO BOUNCER

EN: From birth up to 9 kg / 20 lbs (approx. 6 months)

DE: Ab Geburt bis 9 kg / 20 lbs (ca. 6 Monate)

FR: De la naissance à 9kg / 20 lbs (6 mois environ)

ES: Desde el nacimiento hasta los 9 kg / 20 lbs (aprox. 6 meses)

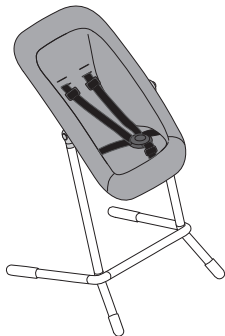

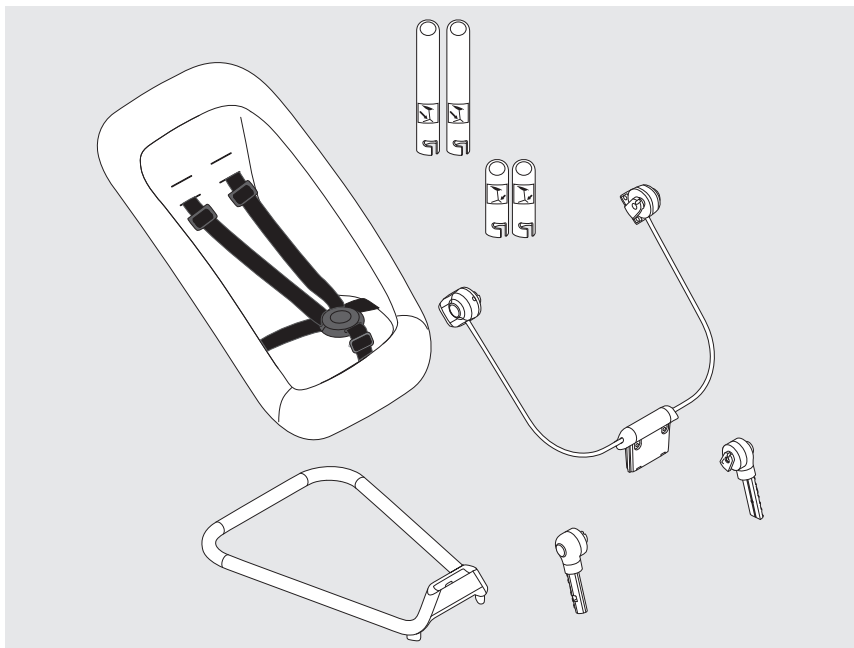

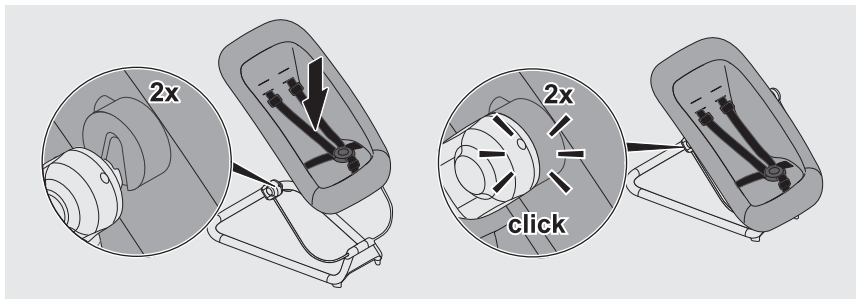
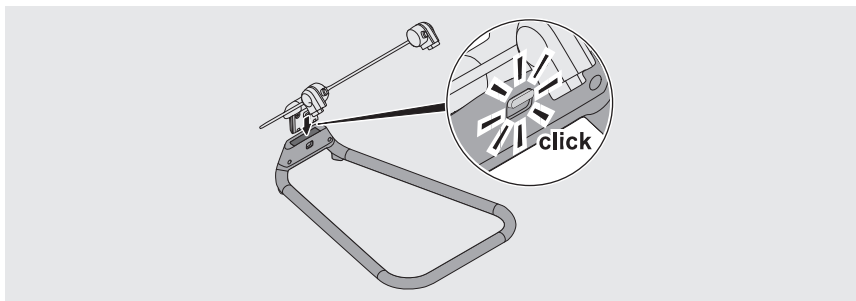

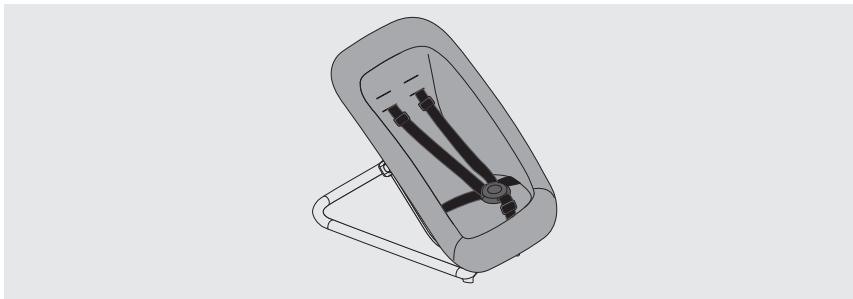

3

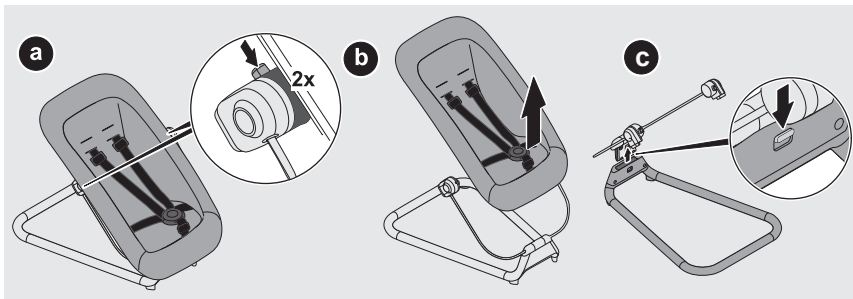

4

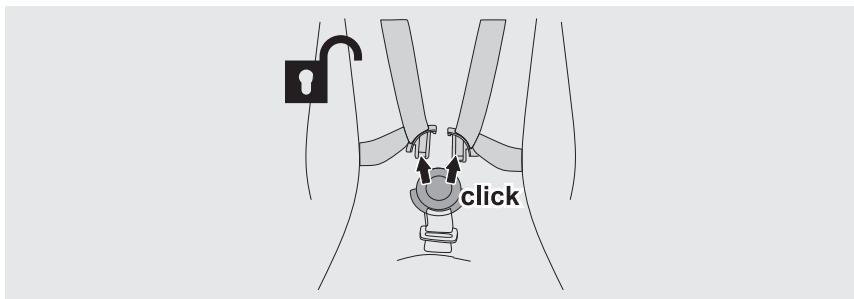
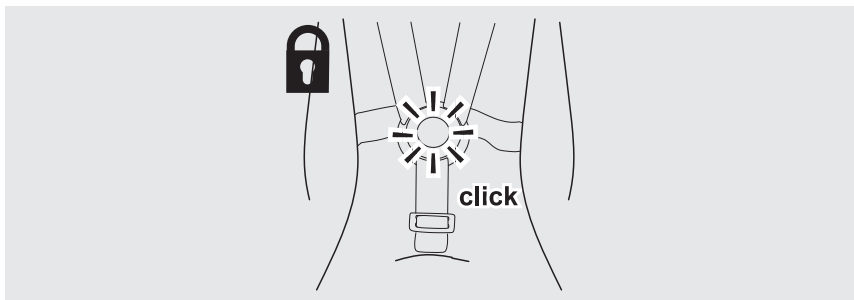

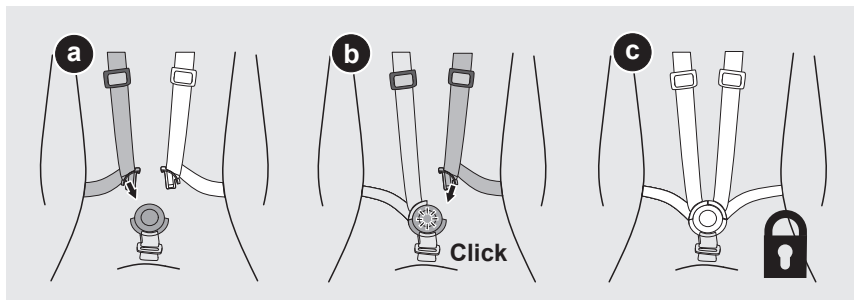

3

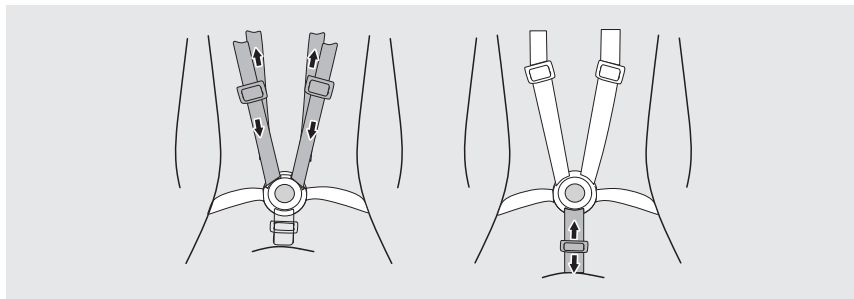

4

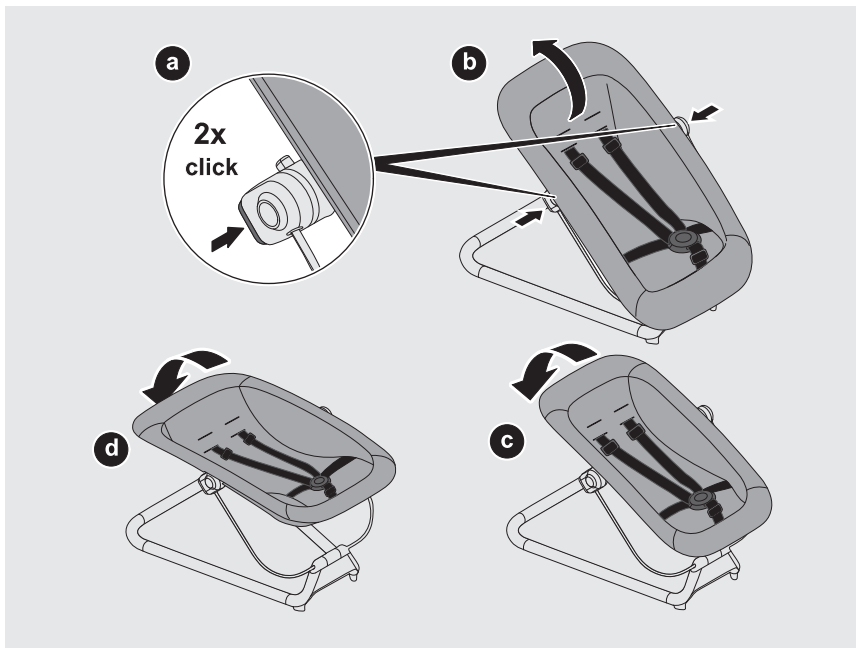

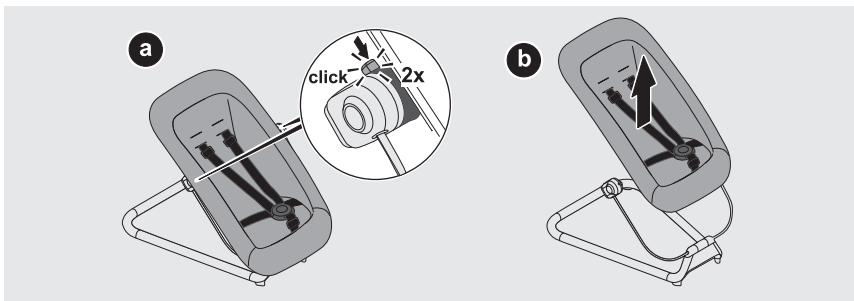

1

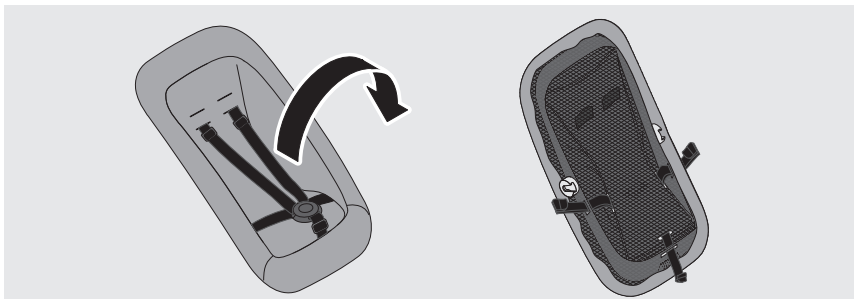

2



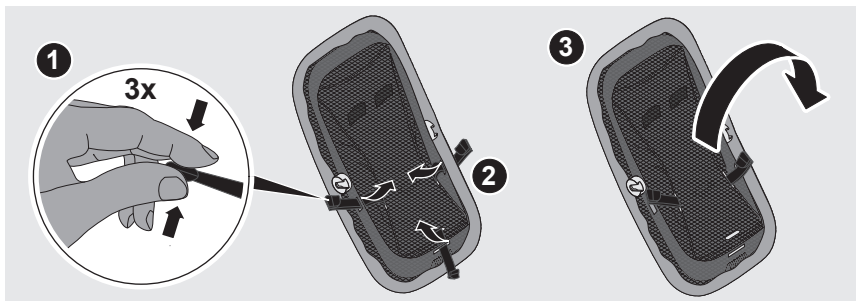

3

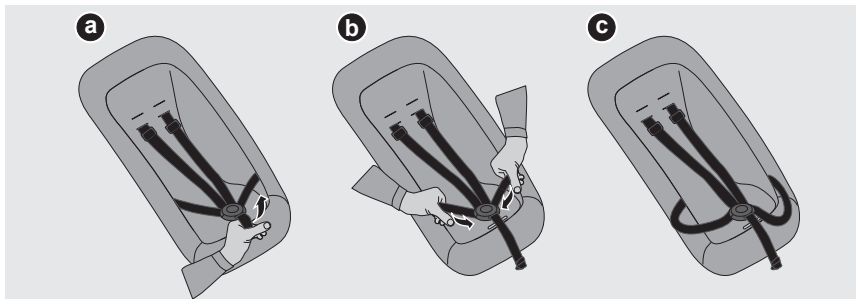

4

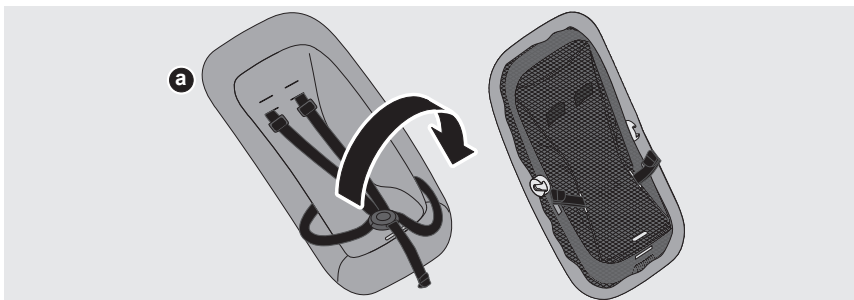

5

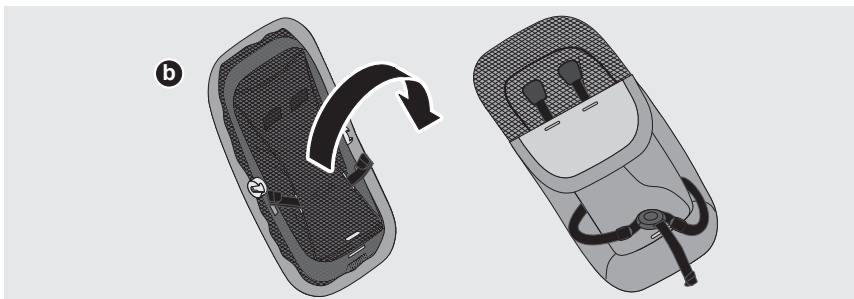

6



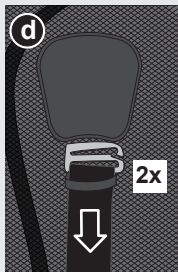
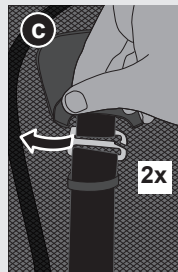
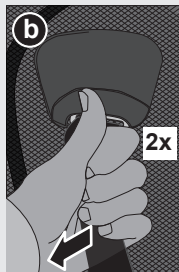
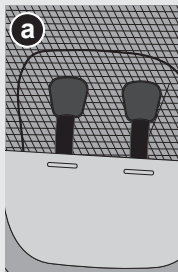

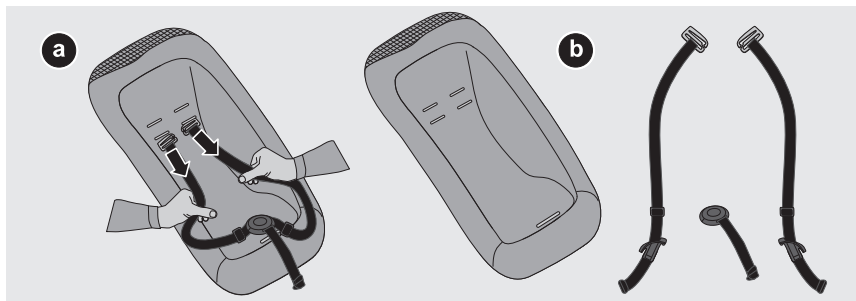

8

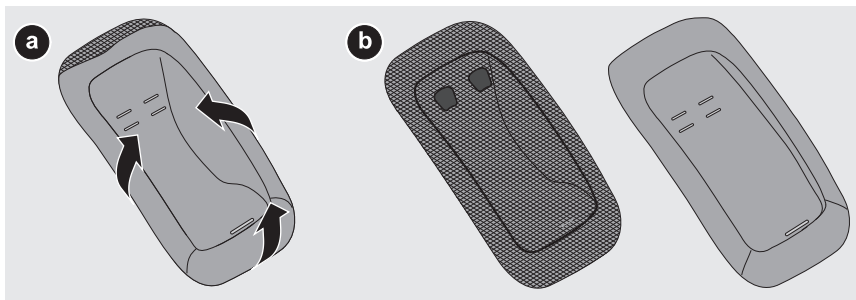

9

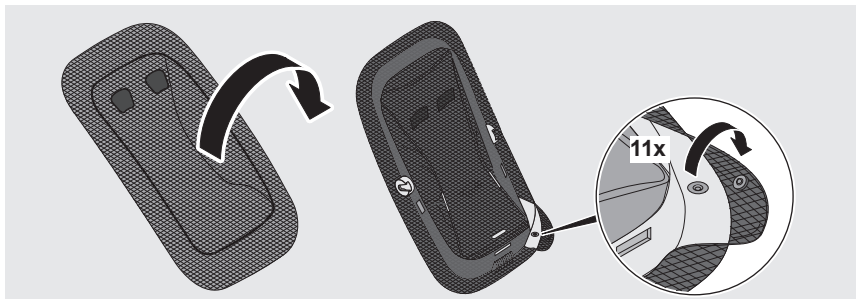

10



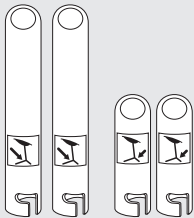
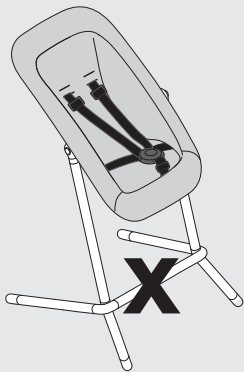

 MAX. 9kg/20lbs



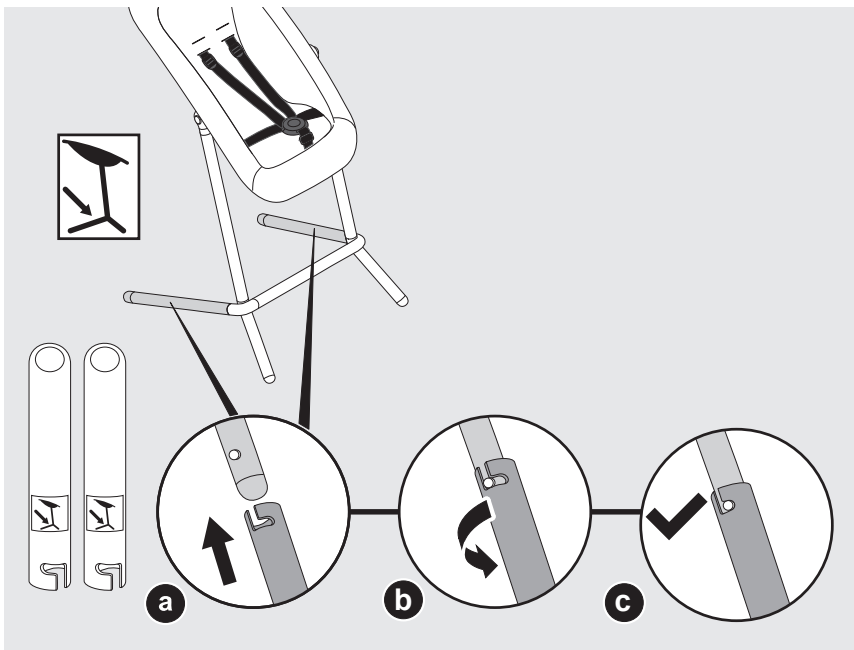

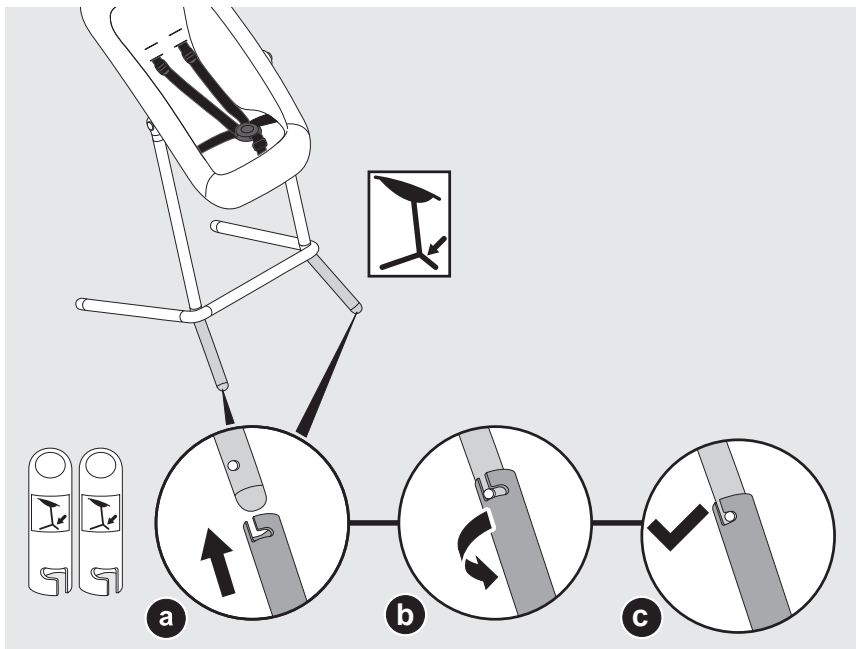

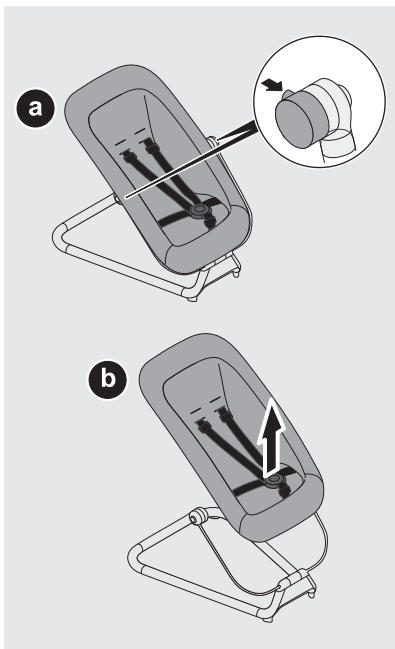

3

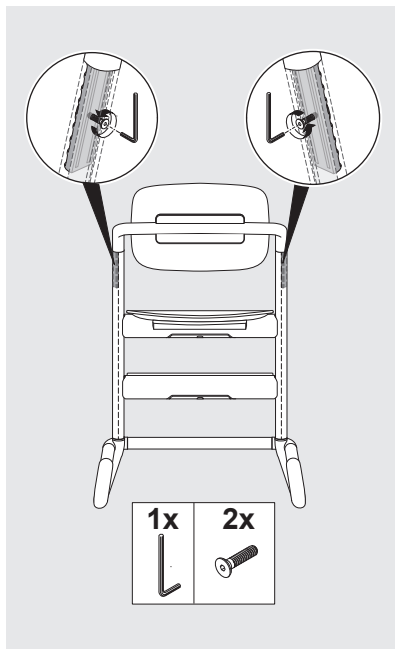

4



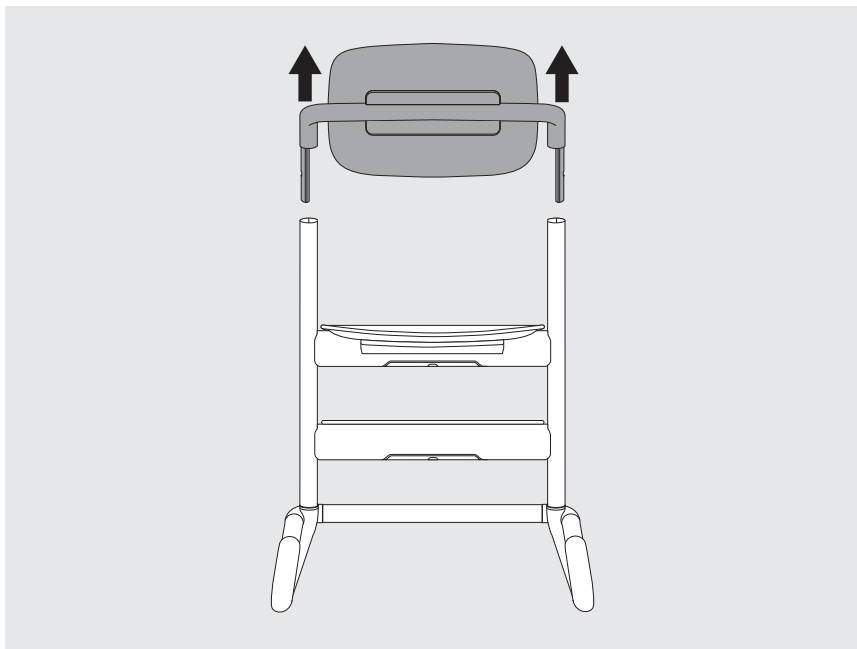

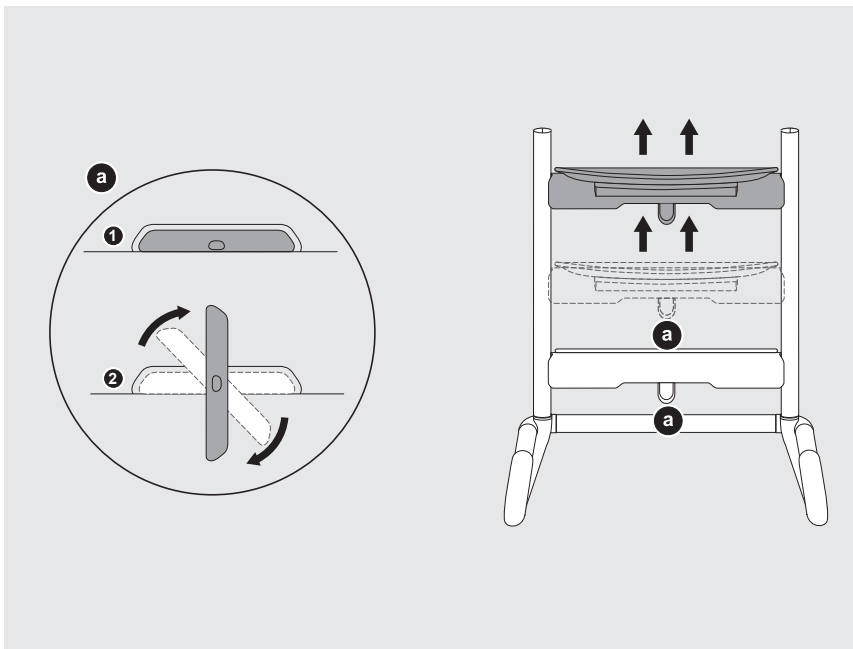

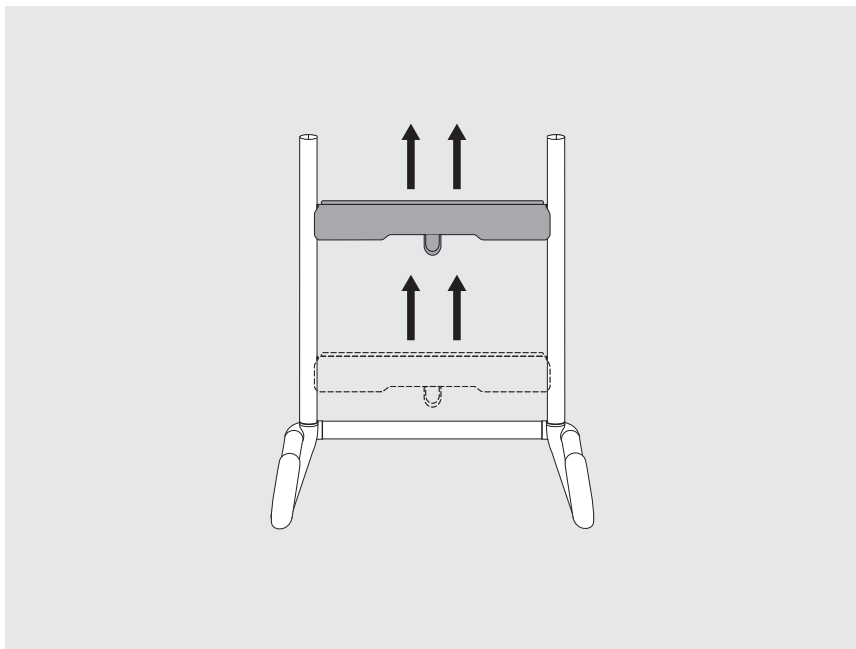

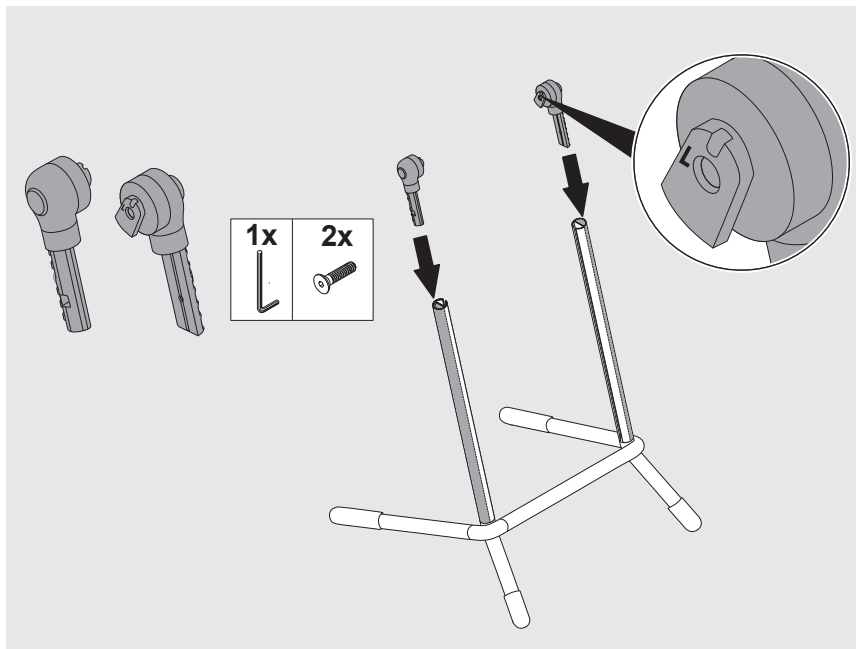

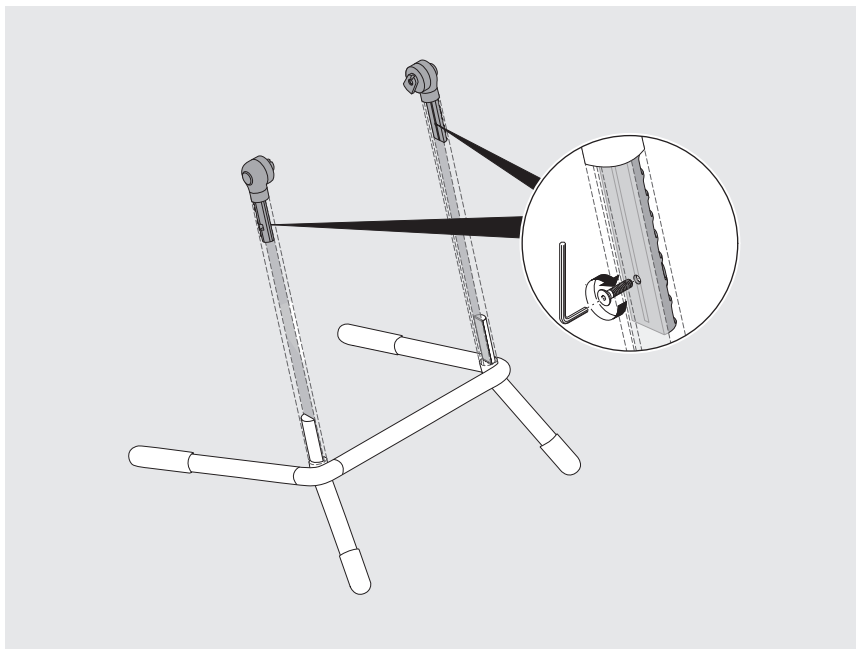

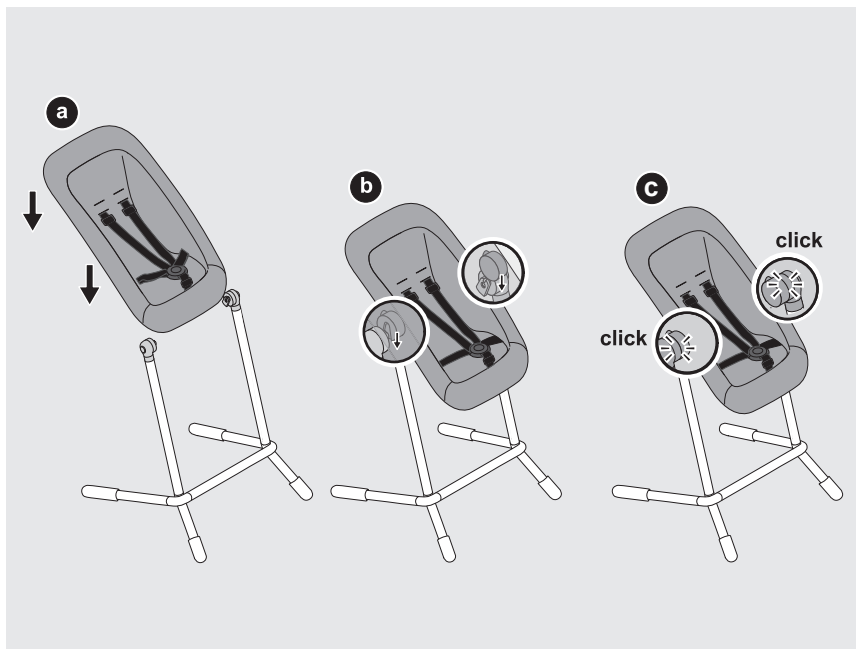

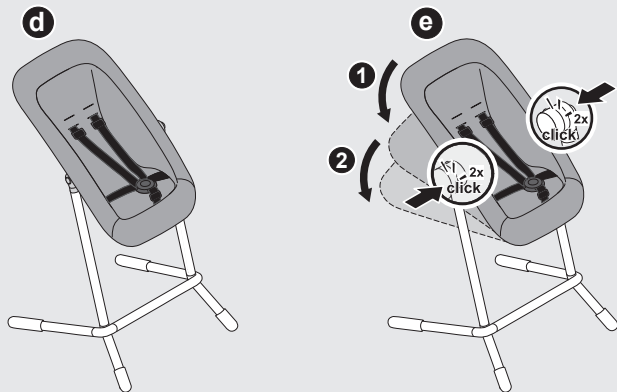

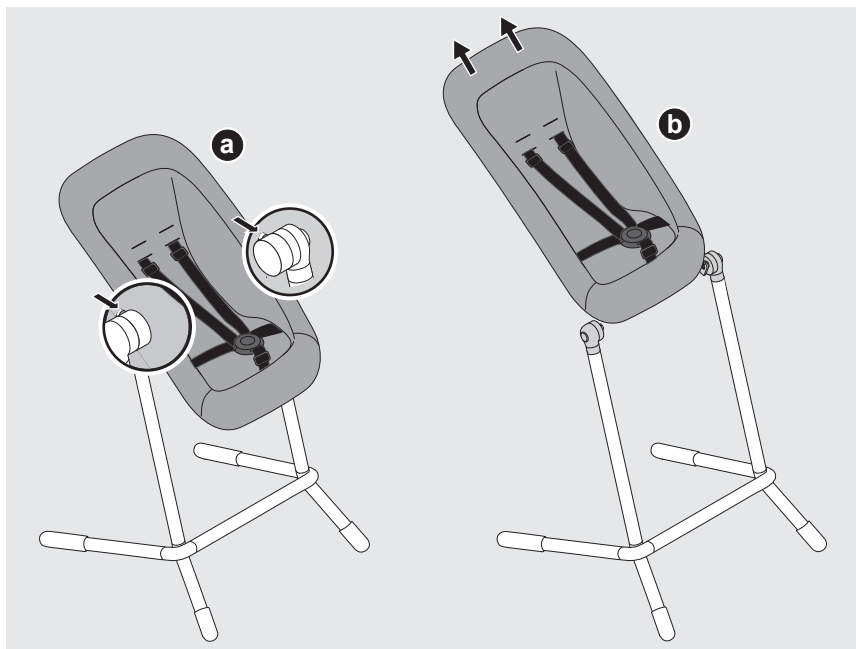

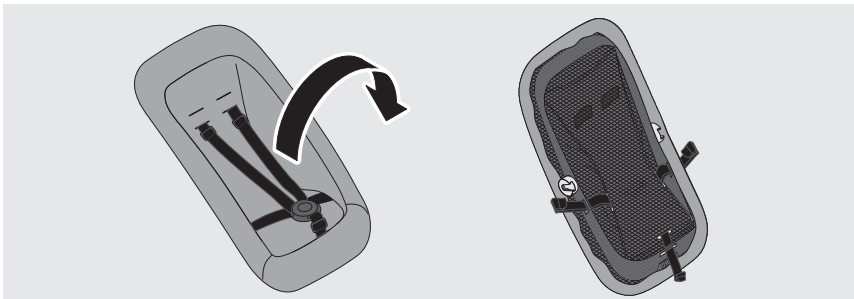

1

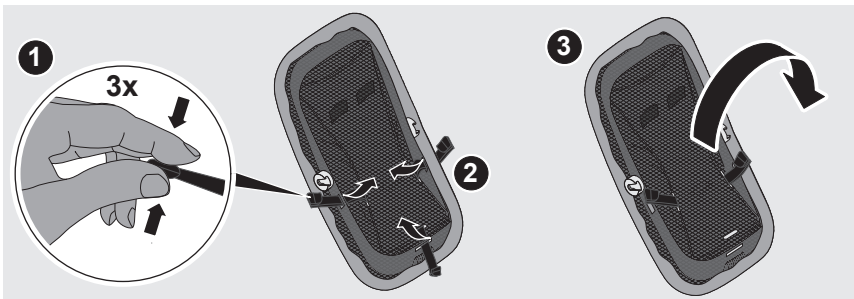

1

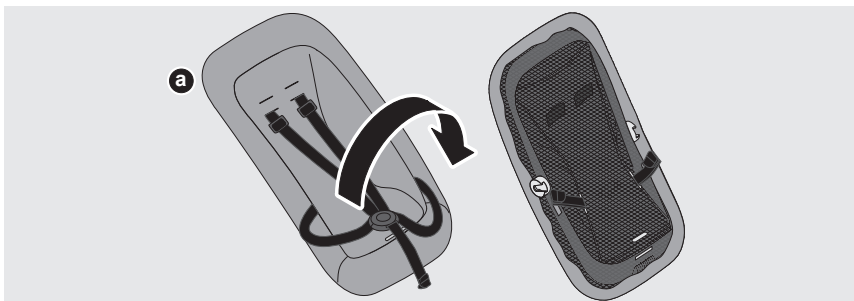

2

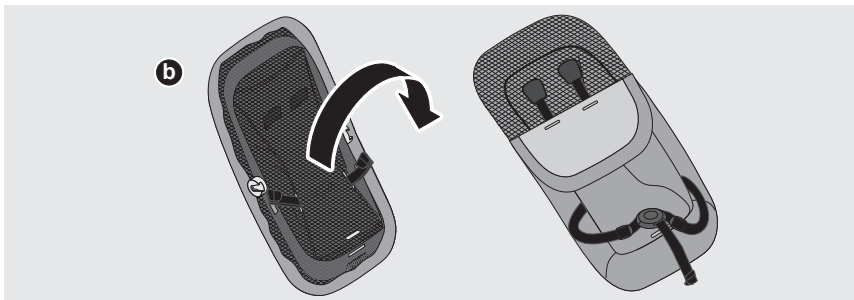

3



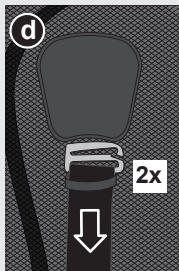
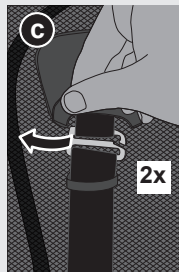
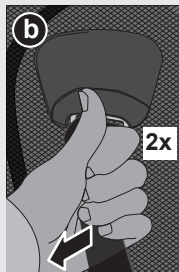
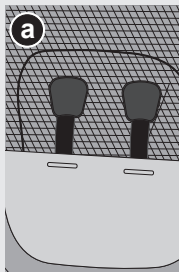

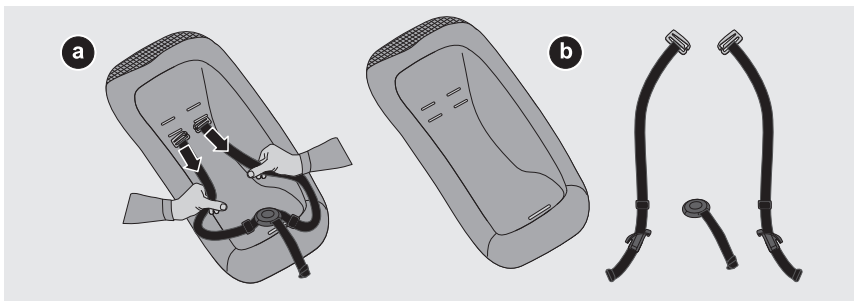

5

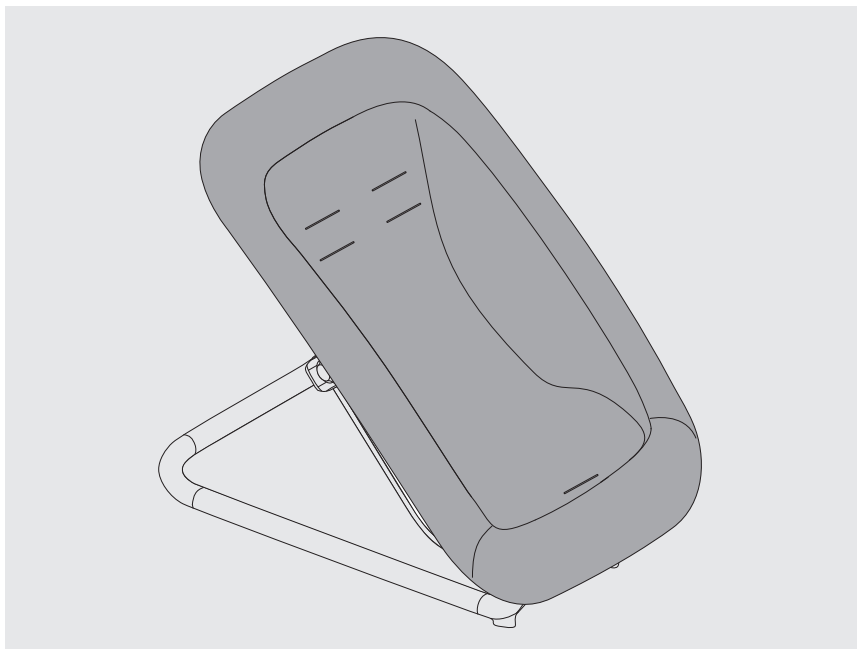







CONTACT

Europe and Asia

CYBEX GmbH
Riedingerstr. 18
95448 Bayreuth
Germany
+49 (0) 921-78 511 - 0
info@cybex-online.com

Americas

Columbus Trading-Partners USA Inc.
1801 Commerce Dr.
Piqua, OH 45356
USA
Customer Service 1-844-543-2020
support.us@columbustp.com



www.cybex-online.com