

WARNING! US/CAN-EN

- Ensure that adapters are secured before connecting an infant seat.
- Refer to infant seat manual for weight limit and harness use. Always use harness to secure child.
- Never leave child unattended.
- Warning: Failure to follow all warnings and instructions may result in serious injury or death.
- Always use the highest handle position when using an infant car seat on position or .

MISE EN GARDE! US/CAN-FR

- Assurez-vous que les adaptateurs sont sécurisés avant de connecter un siège pour enfant.
- Consultez le manuel du siège pour enfant pour connaître la limite de poids et le mode d'emploi du harnais. Utilisez toujours le harnais pour sécuriser l'enfant.
- Ne jamais laisser l'enfant sans surveillance.
- Mise en garde. Le non-respect de ces mises en garde et de ces instructions peut entraîner des blessures graves ou la mort.
- Utilisez toujours la position de poignée la plus élevée lorsque vous utilisez un siège auto pour enfant en position ou .

for all tomorrow's people

cybex
cybex-online.com

DUO: GRACO/CHICCO/PEG-PÉRÉGO

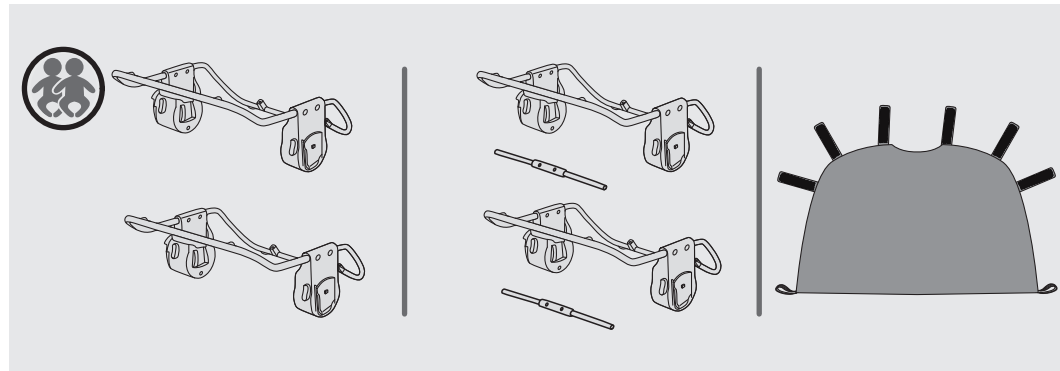

1

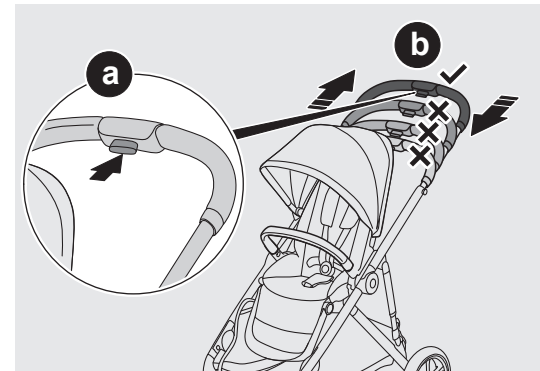

2

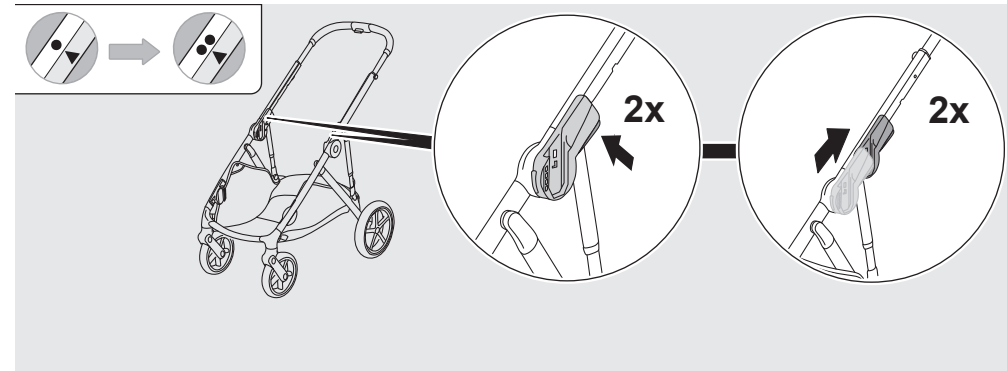

3

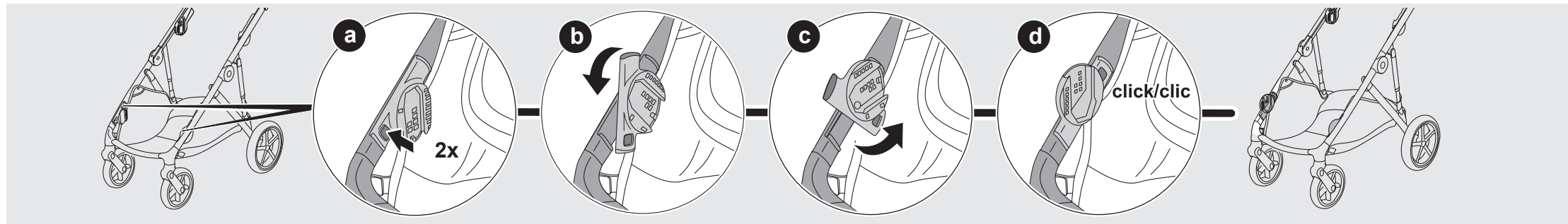

4

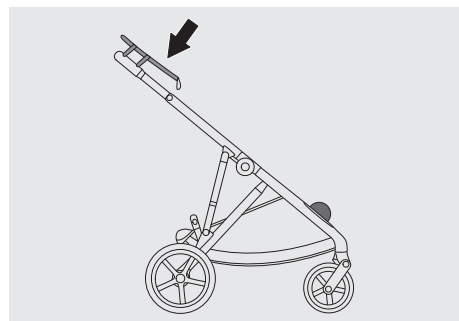

5

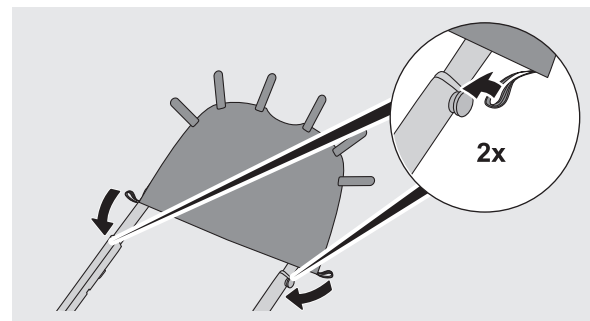

6

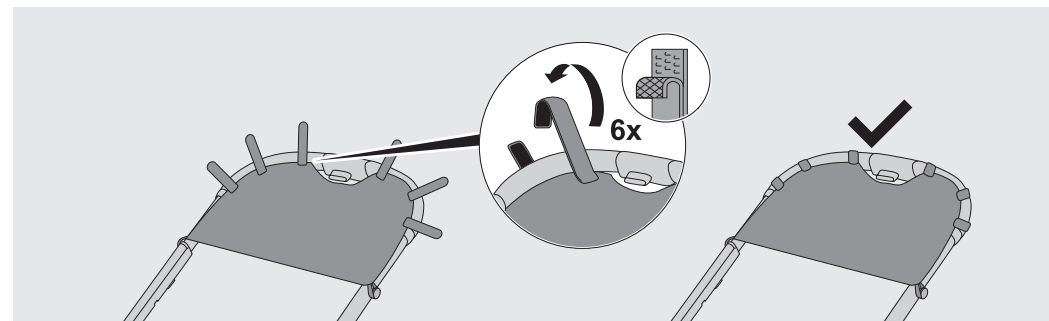

7

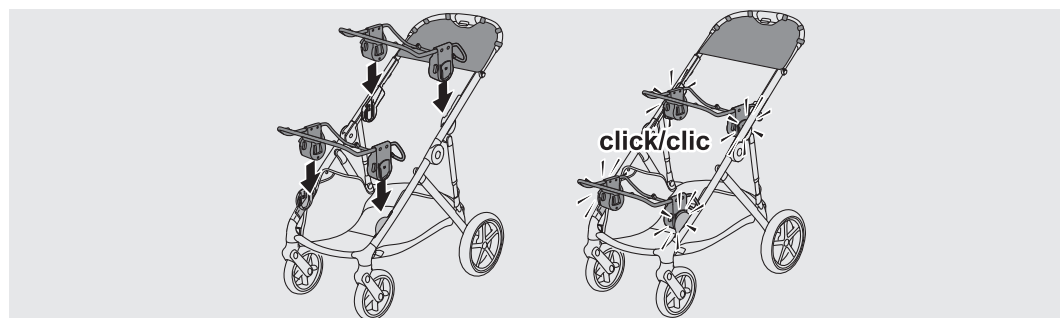

8

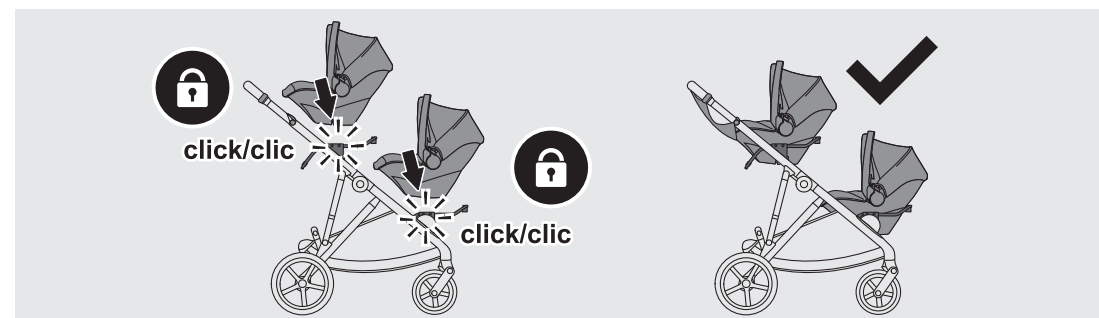

9

info@cybex-online.com
+49 (0) 921-78 611-0
Germany
95448 Bayreuth
Friedingerstraße 18
CYBEX GmbH

cybex
GOLD

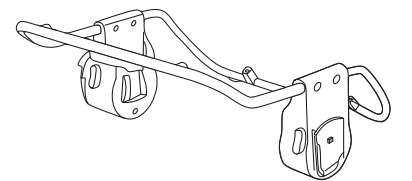

**CAR SEAT
ADAPTERS
ADAPTATEURS
POUR COQUE
GAZELLE S**

GRACO/CHICCO

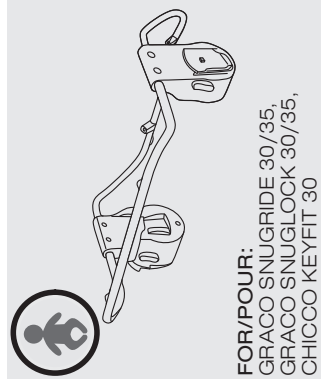

FOR/POUR:
GRACO SNUGRIDE 30/35,
GRACO SNUGLOCK 30/35,
CHICCO KEYFIT 30

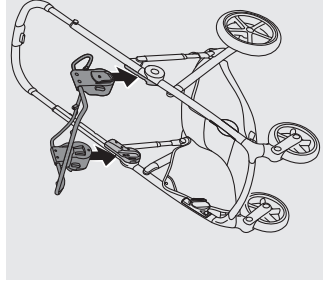

click/clic

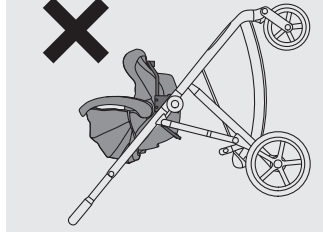
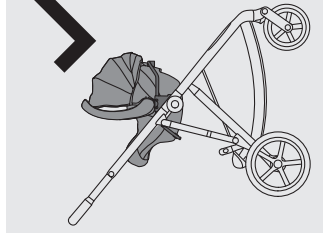
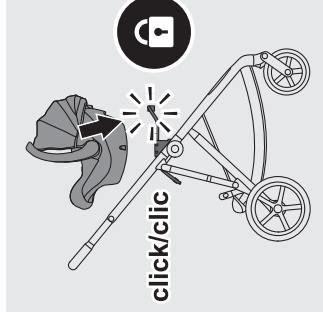
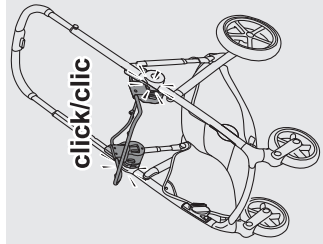

1

2

3

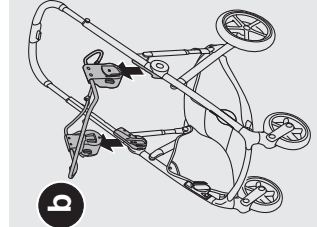
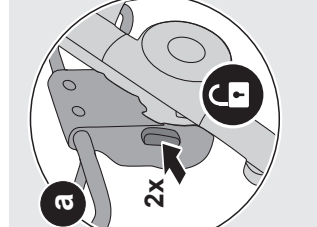
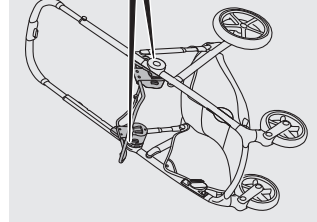
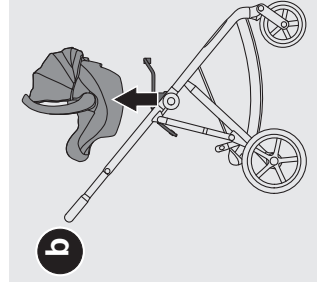
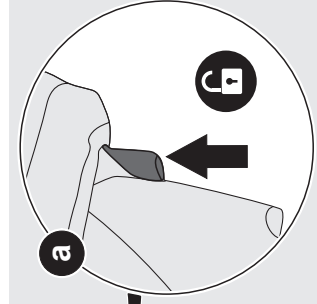
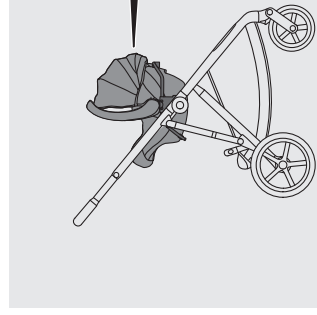

4

a

b

5

6

PEG-PÉREGO

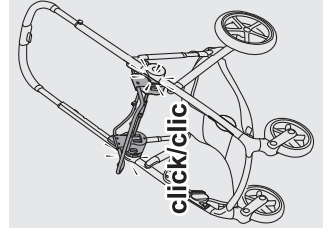
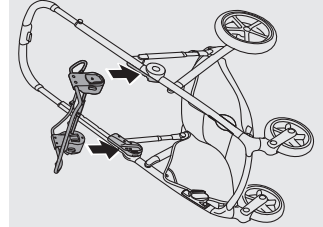
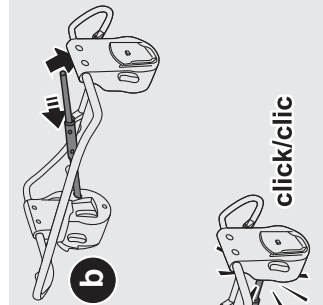
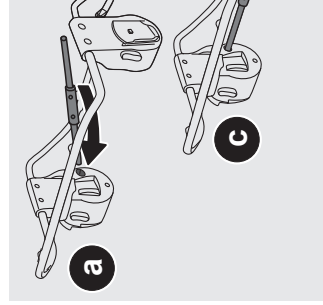
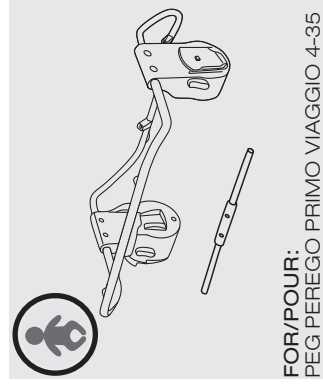

1

2

3

4

5

6

7

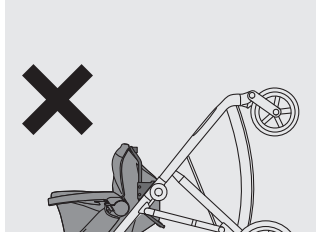
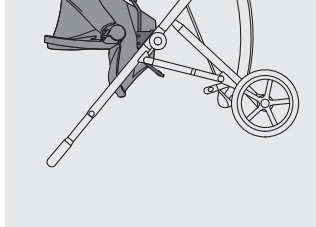
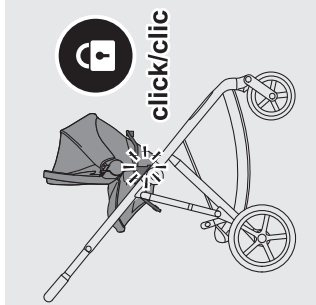
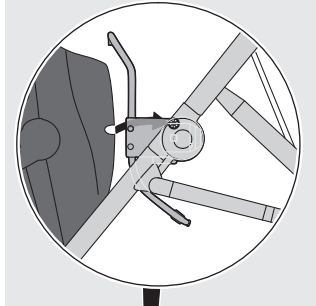
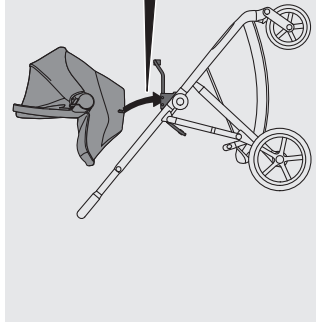

4

a

b

5

6

7

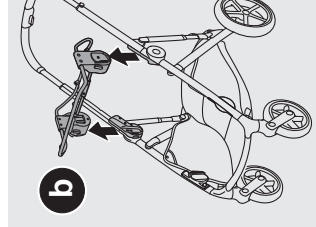
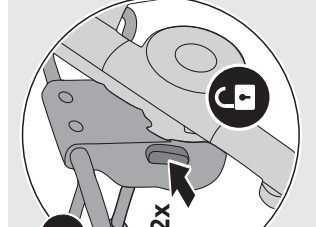
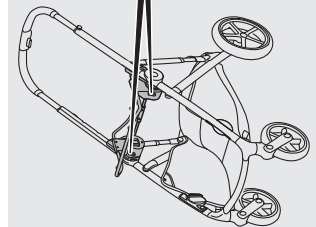
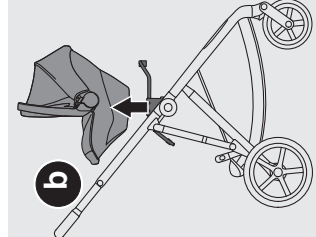
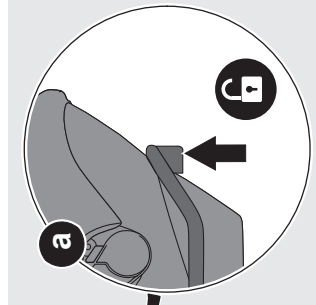
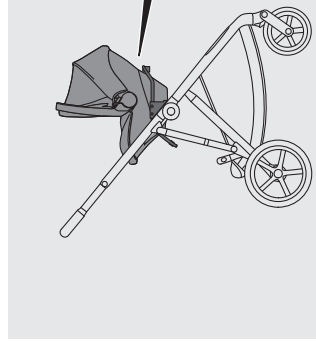

4

a

b

5

6

7